



TOWABLE  
MASTER MANUAL

LIPPERT  
COMPONENTS®



# TABLE OF CONTENTS

<b>IN-WALL™ SLIDE-OUT</b>	<b>9</b>
<b>Prior To Operation</b>	<b>9</b>
<b>Operation</b>	<b>10</b>
Extending Slide-Out Room	10
Retracting Slide-Out Room	10
Electronic Manual Override (Controllers C-1 and C-2 Only)	13
Extend and Retract Switch Connections	13
Power and Ground Connections At The Controller	13
Error Codes	13
Obstructions	14
Checking Fuses	14
Motors and Harnesses	14
Resynchronizing The Slide-Out Motors	14
<b>ABOVE FLOOR SOFA SLIDE-OUT</b>	<b>15</b>
<b>Safety Information</b>	<b>15</b>
<b>Product Information</b>	<b>15</b>
<b>Prior To Operation</b>	<b>15</b>
<b>Operation</b>	<b>16</b>
Extending Slide-Out Room	16
Retracting Slide-Out Room	16
<b>Maintenance</b>	<b>16</b>
Preventative	16
Electric	16
Mechanical Maintenance	17
<b>Troubleshooting</b>	<b>17</b>
Troubleshooting Introduction	17
Switch Related Problems:	17
Manual Override	19
Room Adjustment	20
<b>ELECTRIC THROUGH FRAME SLIDE-OUT</b>	<b>21</b>
<b>System Information</b>	<b>21</b>
<b>Safety Information</b>	<b>21</b>
<b>Prior To Operation</b>	<b>21</b>
<b>Operation</b>	<b>22</b>
Extending Slide-Out Room	22
Retracting Slide-Out Room	22
<b>Maintenance</b>	<b>23</b>
Inspection	23
Electrical System Maintenance	23
Mechanical Maintenance	23
<b>Adjustments</b>	<b>24</b>
Horizontal Adjustment	24
Vertical Adjustment	24
Synchronizing Room Travel	24
<b>Troubleshooting</b>	<b>25</b>
Troubleshooting Introduction	25
Manual Override	26
Manual Override - Outside Frame	26
Manual Override - Inside Frame	28
Removing and Replacing Actuator	29
<b>Wiring Diagram</b>	<b>30</b>

<b>HYDRAULIC THROUGH FRAME SLIDE-OUT</b>	<b>31</b>
<b>System Information</b>	<b>31</b>
<b>Safety Information</b>	<b>31</b>
<b>Prior To Operation</b>	<b>32</b>
<b>Operation</b>	<b>32</b>
Extending Slide-Out Room	32
Retracting Slide-Out Room	32
<b>Maintenance</b>	<b>33</b>
Inspection	33
Electrical Maintenance	33
Mechanical Maintenance	33
Fluid Recommendation	34
<b>Adjustments</b>	<b>35</b>
Adjusting The Room To Seal In The IN Position	35
Adjusting The Room To Seal In The OUT Position	35
Horizontal Adjustment	36
Vertical Adjustment	36
Synchronizing Room Travel	36
<b>Troubleshooting</b>	<b>37</b>
Manual Override	37
Motor Unit	37
<b>Wiring Diagram</b>	<b>39</b>
<b>Cylinder Port Locations</b>	<b>40</b>
<b>LEVEL-UP®</b>	<b>41</b>
<b>System Information</b>	<b>41</b>
<b>Safety Information</b>	<b>41</b>
<b>Touch Pad Diagram</b>	<b>42</b>
<b>Prior To Operation</b>	<b>43</b>
<b>Operation</b>	<b>43</b>
Basic Jack Operation	43
Unhitching Instructions	43
Auto Level	44
Auto Level Sequence	44
Hitch Recognition	44
<b>Travel Trailer Operation</b>	<b>45</b>
Unhitching Instructions	45
Auto Level	45
Auto Level Sequence	45
Hitch Recognition	45
<b>Manual Operation</b>	<b>46</b>
<b>Zero Point Calibration</b>	<b>47</b>
<b>Maintenance</b>	<b>47</b>
<b>Troubleshooting</b>	<b>47</b>
Error Display In LCD Screen	47
Manual Override	48
<b>Wiring Diagram</b>	<b>49</b>

<b>GROUND CONTROL® 2.0</b>	<b>50</b>
<b>System and Safety Information</b>	<b>50</b>
<b>Prior To Operation</b>	<b>50</b>
<b>Operation</b>	<b>50</b>
Basic Jack	50
<b>Touch Pad Diagram</b>	<b>51</b>
Dropping off Unit	52
Taking Up Strut Pin Slop (If J.T Strong Arm Stabilizers Are Installed ONLY)	53
Reconnecting The Unit To A Tow Vehicle	53
Truck Hauler Operation (Manual ONLY)	53
<b>Calibration</b>	<b>53</b>
Setting The Zero Point	53
<b>Troubleshooting</b>	<b>54</b>
Special Jack Error Codes	54
<b>Preventative Maintenance</b>	<b>54</b>
Touch Pad - Error Codes	55
<b>GROUND CONTROL® 3.0</b>	<b>56</b>
<b>Safety Information</b>	<b>56</b>
<b>Prior To Operation</b>	<b>56</b>
<b>Touch Pad Diagram</b>	<b>57</b>
<b>Operation</b>	<b>58</b>
Basic Jack Operation	58
Unhitching From A Tow Vehicle	58
Auto Level	59
Auto Level Sequence	59
Hitch Recognition	60
Homing Jacks	60
<b>Calibration</b>	<b>61</b>
Setting The Zero Point	61
<b>Preventive Maintenance</b>	<b>61</b>
<b>Troubleshooting</b>	<b>62</b>
Manual Override - Top of Jack Motor	62
Manual Override - Bottom of Jack Motor	63
Touch Pad - Error Codes	64
Special Jack Error Codes	65
<b>HYDRAULIC LANDING GEAR</b>	<b>66</b>
<b>Safety Information</b>	<b>66</b>
<b>System Information</b>	<b>66</b>
Component Information	66
<b>Prior To Operation</b>	<b>66</b>
<b>Operation</b>	<b>67</b>
<b>Maintenance</b>	<b>67</b>
Mechanical Components	67
Electrical Components	68
Fluid Recommendation	68
<b>Troubleshooting</b>	<b>69</b>
Power Unit	69
Manual Override	70

<b>ELECTRIC STABILIZER JACK</b> .....	<b>71</b>
<b>Safety Information</b> .....	<b>71</b>
<b>System Information</b> .....	<b>71</b>
<b>Operation</b> .....	<b>72</b>
Extending Stabilizer Jack .....	<b>72</b>
Retracting Stabilizer Jack .....	<b>72</b>
<b>Maintenance</b> .....	<b>72</b>
Mechanical Maintenance .....	<b>72</b>
Electrical Maintenance .....	<b>72</b>
<b>Troubleshooting</b> .....	<b>73</b>
Manual Override .....	<b>73</b>
<b>ELECTRIC TONGUE JACK</b> .....	<b>74</b>
<b>Safety Information</b> .....	<b>74</b>
<b>Operation</b> .....	<b>75</b>
Extending The Tongue Jack .....	<b>75</b>
Retracting The Tongue Jack .....	<b>75</b>
<b>Troubleshooting</b> .....	<b>76</b>
Manual Operation .....	<b>76</b>
Power Tongue Jack Clutch .....	<b>77</b>
<b>TRAILER AXLES</b> .....	<b>78</b>
<b>Safety Information</b> .....	<b>78</b>
<b>Electric Drum Brakes</b> .....	<b>78</b>
<b>Hubs/Drums/Bearings</b> .....	<b>79</b>
Hub Removal .....	<b>79</b>
Brake Drum Inspection .....	<b>79</b>
Bearing Inspection .....	<b>80</b>
Bearing Lubrication - Oil .....	<b>81</b>
Bearing Lubrication - Grease .....	<b>81</b>
Seal Inspection and Replacement .....	<b>82</b>
Bearing Adjustment/Hub Replacement .....	<b>82</b>
<b>Electric Brakes</b> .....	<b>83</b>
How To Use Electric Brakes Properly .....	<b>84</b>
<b>Maintenance - Electric Brakes</b> .....	<b>84</b>
Brake Adjustment .....	<b>84</b>
Lubricate Brakes .....	<b>85</b>
Clean and Inspect Brakes .....	<b>85</b>
Magnets .....	<b>85</b>
Shoes and Linings .....	<b>86</b>
<b>Axle and Suspension Installation</b> .....	<b>86</b>
Suspension Systems .....	<b>86</b>
Double-Eye Leaf Springs .....	<b>87</b>
Torsion Suspension System .....	<b>88</b>
Inspection .....	<b>89</b>
Suspension Replacement .....	<b>89</b>
<b>Wheels</b> .....	<b>90</b>
Wheel Selection .....	<b>90</b>
Torque Requirements .....	<b>91</b>
Tires .....	<b>92</b>

<b>Introduction To Troubleshooting</b>	<b>93</b>
Troubleshooting	93
Measuring Voltage	93
Troubleshooting Chart	94
Measuring Amperage	95
Amperage Chart	96
<b>Maintenance Schedule</b>	<b>97</b>
<b>Wiring Diagram</b>	<b>98</b>
<b>Pigtail and Coupler Wiring Color Codes</b>	<b>99</b>
<b>SOLERA® MANUAL AWNING - CRANK STYLE</b>	<b>100</b>
<b>Safety Information</b>	<b>100</b>
<b>Introduction</b>	<b>100</b>
<b>Operation</b>	<b>101</b>
Extending The Awning	101
Retracting The Awning	102
Adjusting Pitch	103
Fabric Care	103
Ordering Replacement Components	103
<b>SOLERA® MANUAL AWNING - PULL STRAP STYLE</b>	<b>104</b>
<b>Safety Information</b>	<b>104</b>
<b>Introduction</b>	<b>104</b>
<b>Operation</b>	<b>104</b>
Extending The Awning	104
Retracting The Awning	106
Adjusting Pitch	107
Fabric Care	107
Ordering Replacement Components	107
<b>SOLERA® POWER AWNING</b>	<b>108</b>
<b>Safety Information</b>	<b>108</b>
<b>Introduction</b>	<b>108</b>
<b>Operation</b>	<b>109</b>
Extending The Awning	109
Retracting The Awning	109
Adjusting Pitch	110
Fabric Care	110
Ordering Replacement Components	110
Manual Override	111
<b>FASTEC ENTRY DOOR LATCH</b>	<b>112</b>
<b>RV LOCK™ KEYLESS ENTRY DOOR LATCH</b>	<b>113</b>
<b>Installation</b>	<b>113</b>
Removal of Existing Handle	113
Installing The RV Lock™	113
Programming The RV Lock™	113
Programming A New Code Into Your RV Lock™ Keypad	114
Syncing The RV Lock™ Handle With Your Keypad or Remotes	115
Keypad Programming Instructions	115
RV Lock™ Handle Programming Instructions	115
Troubleshooting	116
FAQs	116

<b>SOUTHCO® KEYLESS ENTRY DOOR LATCH</b>	117
<b>BAUER NE LOCK</b>	119
<b>Product Information</b>	119
Features	119
<b>Operation</b>	119
<b>Calibration and Programming</b>	120
Preset Factory Code	120
Programming New Code	120
<b>Maintenance</b>	120
<b>Installation</b>	121
Bauer NE Installation	121
Battery Installation	122
Battery Plug Instructions	122
<b>Troubleshooting</b>	123
Bauer NE Fault Logic	123
<b>Limited Warranty</b>	123
<b>MANUAL STEPS</b>	124
<b>Steel Step Operation</b>	124
Unfolding Steps	124
Folding Steps	124
<b>Aluminum Step Operation</b>	125
Unfolding Steps	125
Folding Steps	125
<b>Scratch Maintenance</b>	125
<b>Lubrication of Hinge Areas</b>	125
<b>CHASSIS INFORMATION</b>	126
<b>Lippert Chassis</b>	126
Maintenance	126
Issues Resulting From Improper Maintenance	126
I-Beam Camber	126
Axle Hangers	126
<b>Axles</b>	129
Bearings	129
Brakes	129
Connecting Components	129
Recommendations For Jacking The Frame To Change A Tire	129
<b>Kinro</b>	129
Windows	129
Cargo Doors	129
Ramp Doors	129
<b>Slide-Outs</b>	130
<b>Electric Landing Gear</b>	130
<b>Hydraulic Landing Gear - Level-Up Jacks - Rear Hydraulic Stab Jacks</b>	130
<b>Hydraulic Power Units</b>	130
<b>Maintenance Free Systems</b>	130
<b>NOTES</b>	131



## SLIDE-OUTS

**Safety Information**

**Failure to act in accordance with the following may result in death, serious injury, coach or property damage.**

The IN-WALL™ Slide-out System is intended for the sole purpose of extending and retracting the slide-out room. Its function should not be used for any purpose or reason other than to actuate the slide-out room. To use the system for any reason other than what it is designed for may result in death, serious injury or damage to the coach.

Before actuating the system, please keep these things in mind:

1. Parking locations should be clear of obstructions that may cause damage when the slide-out room is actuated.
2. Be sure all persons are clear of the coach prior to the slide-out room actuation.
3. Keep hands and other body parts away from slide-out mechanisms during actuation.
4. To optimize slide-out actuation, park coach on solid and level ground.

**Prior To Operation**

1. Park the coach on the most level surface available.
2. Actuate the leveling or stabilizing systems to ensure coach will not move during operation of slide-out system.
3. Be sure battery is fully charged.
4. Be sure to keep all persons and pets clear of slide-out system during operation.

**NOTE:** Install transit bars (if so equipped) on the slide-out room during storage and transportation.



**Always make sure that the slide-out room path is clear of people and objects before and during operation of the slide-out. Always keep away from the gear racks when the room is being operated.**

## Operation

### Extending Slide-Out Room

1. Level the unit.
2. Verify the battery is fully charged and hooked up to the electrical system.
3. Remove the transit bars (if so equipped).
4. Press and hold the IN/OUT switch (Fig. 1B) in the OUT position until the room is fully extended and stops moving.

**NOTE:** It is important to continue to press the slide-out switch for a few seconds after the room is fully extended until the motor shuts off. The control will sense that the room has stopped and will shut off the motor after a few seconds.

5. Release the switch, which will lock the room into position.

### Retracting Slide-Out Room

1. Verify the battery is fully charged and hooked-up to the electrical system.
2. Press and hold the IN/OUT switch (Fig. 1A) in the IN position until the room is fully retracted and stops moving.

**NOTE:** It is important to continue to press the slide-out switch for a few seconds after the room is fully retracted until the motor shuts off. The control will sense that the room has stopped and will shut off the motor after a few seconds.

3. Release the switch, which will lock the room into position.
4. Install the transit bars (if so equipped).

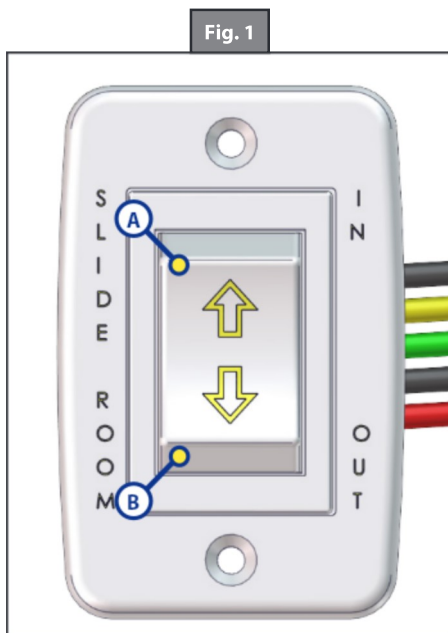

## Troubleshooting

### Controller Overview (B Version)

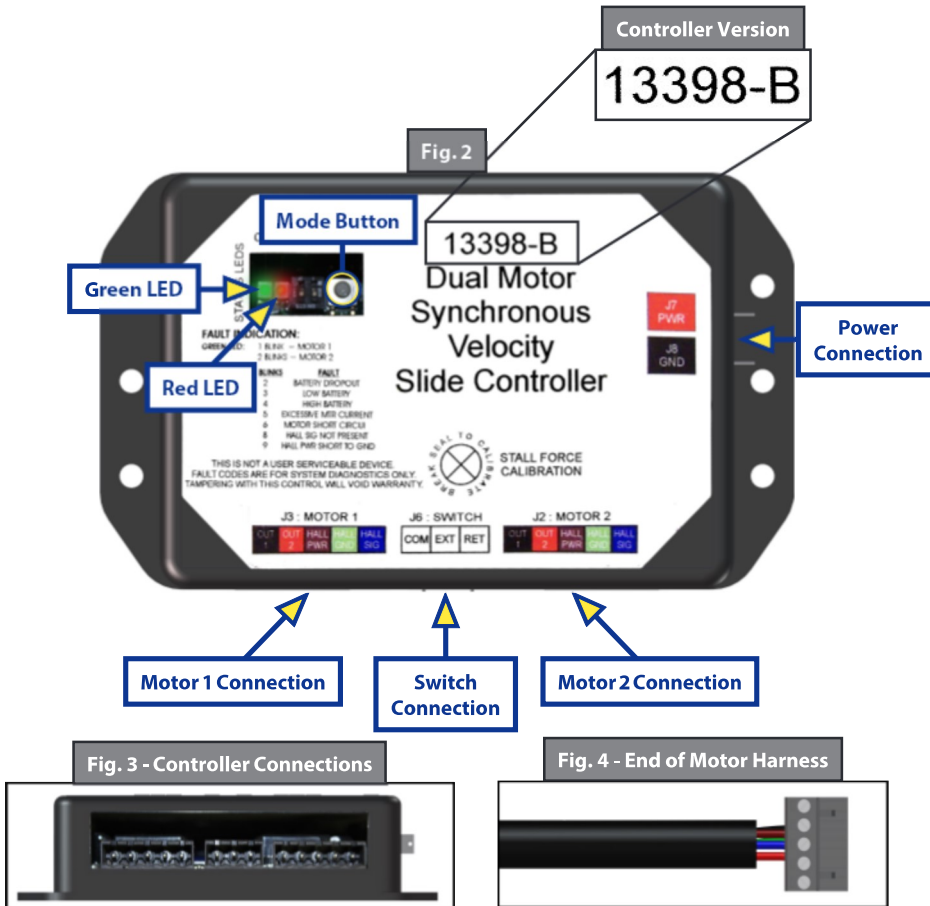

**Status LEDs:** 2 LEDs, 1 green and 1 red, are provided to indicate current controller status and faults.

**Power Connection:** 12V DC input. Unit will operate from 8V DC to 18V DC.

**Switch Connection:** Spade connection for the switch wiring.

**Motor 1 Connector:** Power and encoder input for motor 1.

**Motor 2 Connector:** Power and encoder input for motor 2.

**NOTE:** Version B motor harnesses have five wire in-line connectors at the controller and the molded connector at the motor end (Figs. 3 and 4). Wire colors match with color codes on control board. It does not matter which motor is 1 or 2.

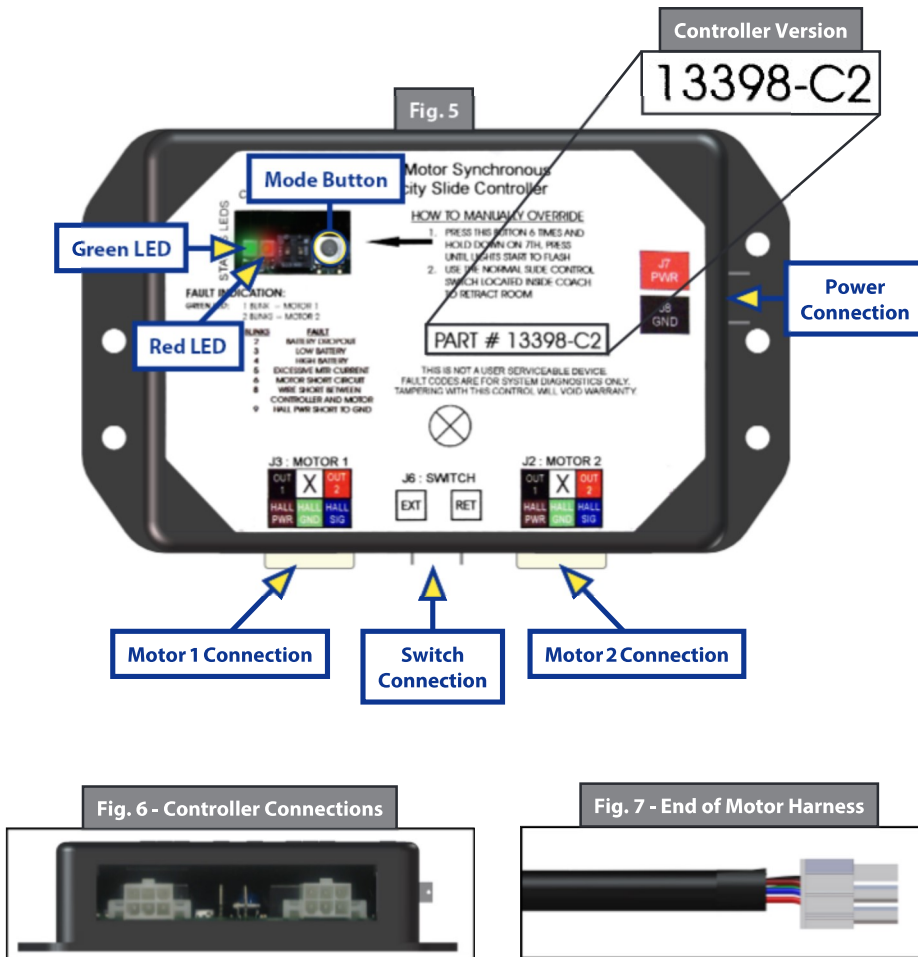

**Status LEDs:** 2 LEDs, 1 green and 1 red, are provided to indicate current controller status and faults.

**Mode Button:** Used to engage the electronic manual override.

**Power Connection:** 12V DC input. Unit will operate from 8V DC to 18V DC.

**Switch Connection:** Spade connection for the switch wiring.

**Motor 1 Connector:** Power and encoder input for motor 1.

**Motor 2 Connector:** Power and encoder input for motor 2.

**NOTE:** Motor harnesses have Molex® connectors at the controller and the molded connector at the motor end (Figs. 6 and 7). Wire colors match with color codes on control board. It does not matter which motor is 1 or 2.

### Electronic Manual Override (Controllers C-1 and C-2 Only)

**NOTE:** See (Fig. 5) for locations of the mode button and LEDs.

1. Press the mode button on the controller six times and hold on the seventh for five seconds to enter electronic manual override mode.
2. Use the extend/retract switch to move both motors in or out.

**NOTE:** Over-current and short circuit detection are disabled. Electronic manual override provides 12V directly to both motors.

3. To exit the mode, push and hold the mode button until the LEDs begin to blink simultaneously. Exiting the override mode resets the motor positions.

#### Extend and Retract Switch Connections

Common connection on controller goes to common connection on extend and retract switch. Extend and retract connections on the controller go to the extend and retract terminals on the switch. Switch is powered by the OEM supplied 12V DC power source.

#### Power and Ground Connections At The Controller

Power and ground are supplied to the controller through the spade terminals located on the right hand side of the controller (Fig. 8A, 8B). 12V DC is recommended. A 10ga wire is the minimum size recommended.

#### Error Codes

During operation when an error occurs the board will use the LEDs to indicate where the problem exists. For motor-specific faults the green LED will blink 1 time for motor 1, and 2 times for motor 2. The red LED will blink from 2 to 9 times depending on the error code.

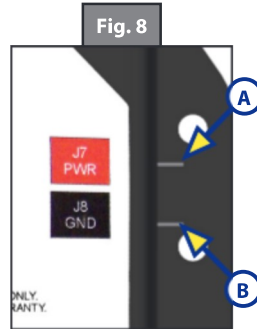

Error Code	Name	Description
2	Battery Drop Out	Battery capacity low enough to drop below 6 volts while running.
3	Low Battery	Voltage below 8 volts at start of cycle.
4	High Battery	Voltage greater than 18 volts.
5	Excessive Motor Current	High amperage, also indicated by 1 side of slide continually stalling.
6	Motor Short Circuit	Motor or wiring to motor has shorted out.
8	Wire Short Between Controller and Motor (Error named "Hall Sig Not Present" on Rev. B controller)	Encoder is not providing a signal, which is usually a wiring problem.
9	Hall Power Short To Ground	Power to encoder has been shorted to ground, which is usually a wiring problem.
When an error code is present, the board needs to be reset. Energizing the extend/retract switch resets the board. Energize the extend/retract switch again for normal operation.		

### Low Voltage

The IN-WALL™ Slide-out Controller is capable of operating the room with as little as 8 volts. But at these lower voltages the amperage requirement is greater. Check voltage at the controller, see pages 4 and 5 for the location of power connections. If voltage is lower than 11 volts, it is recommended that the battery be placed on a charger until it is fully charged. It may be possible to "jump" the RV's battery temporarily to extend or retract the room. Consult the RV manufacturer's owners manual on the procedure for "jumping" or charging the battery.

**NOTE:** Never "jump" or charge the battery from the power connections on the IN-WALL™ Controller. Always do this at the battery.

### Obstructions

Check outside the RV for possible obstructions: tree, post, car, etc. Check inside the RV for any obstructions: luggage, furniture, open cabinets, etc. Also, check for smaller objects that may be wedged under the floor or in the sides of unit. Remove obstructions before proceeding.

### Checking Fuses

The IN-WALL™ Slide-out requires a minimum of a 30-amp fuse. Check the 12-volt fuse box for blown fuses, and replace any if necessary. Consult the RV manufacturer's documentation for the location of the 12-volt fuse box, and the location of the IN-WALL™ Slide-out controller's fuse. If the fuse blows immediately upon replacement, there is a problem with the wiring to the IN-WALL™ Slide-out controller. Have qualified service personnel check and repair.

### Motors and Harnesses

1. Check for proper connections between the motors and harnesses (Fig. 9).
2. Visually inspect the exposed harnesses to ensure they are not pinched or damaged.

**NOTE:** Ribs on motor connector line up with notch inside of male connector on wiring harness. Color codes on wires also match (black to black, red to red, etc.).

### Resynchronizing The Slide-Out Motors

3. Fully extend the slide room using the switch. Keep the switch engaged until the motors shut down on their own.
4. Retract the room 1-2 inches.
5. Repeat steps 1 and 2 until both motors shut down at the same time. In many cases, two or three repetitions are necessary to re-sync the system.
6. Fully extend and then retract the room. Again, always let the motors shut down on their own before releasing the switch.

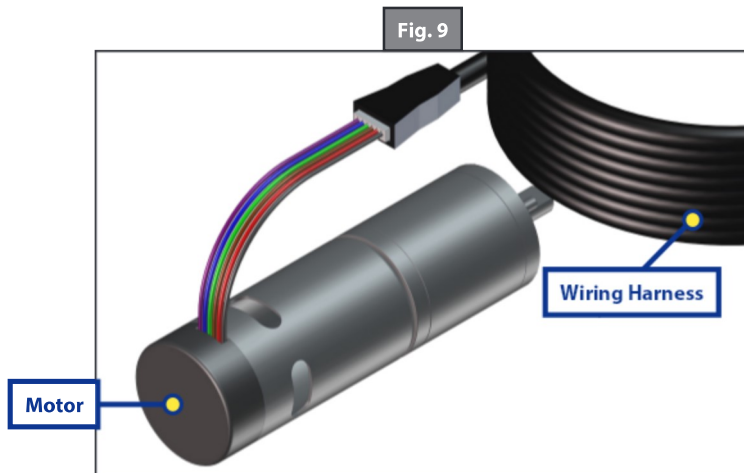

Rev: 09.25.2015 - Towable Master Owners Manual

## SLIDE-OUTS

## Safety Information



**Failure to act in accordance with the following may result in death, serious injury, coach or property damage.**



The Above Floor Sofa Slide-out System is intended for the sole purpose of extending and retracting the slide-out room. Its function should not be used for any other purpose or reason than to actuate the slide-out room. To use the system for any reason other than what it is designed for may result in damage to the coach and/or cause serious injury or even death.

Before actuating the system, please keep these things in mind:

1. Parking locations should be clear of obstructions that may cause damage when the slide-out room is actuated.
2. Be sure all persons are clear of the coach prior to the slide-out room actuation.
3. Keep hands and other body parts away from slide-out mechanisms during actuation. Severe injury or death may result.
4. To optimize slide-out actuation, park coach on solid and level ground.

## Product Information

The Above Floor Sofa Slide-out System is a rack and pinion style slide system. Utilizing a bi-directional electric motor to actuate the drive shaft, the slide-out room is extended and retracted from the same source. The actuator has a built-in automatic braking feature. The Above Floor Sofa Slide-out is designed as a negative or positive ground system.

-  There are no serviceable parts within the electric motor. If the motor fails, it **MUST** be replaced.
-  Disassembly of the motor voids the warranty.
-  Mechanical portions of the slide-out system are replaceable. Contact Lippert Components, Inc. to obtain replacement parts.

## Prior To Operation

Prior to operating the Above Floor Sofa Slide-out System, follow these guidelines:

1. Coach should be parked on the most level surface available.
2. Leveling or stabilizing system should be actuated to ensure coach will not move during operation of slide-out system.
3. Be sure battery is fully charged.
4. Be sure to keep all persons and pets clear of slide-out system during operation.



**Always make sure that the slide-out room path is clear of people and objects before and during operation of the slide-out room. Always keep away from the slide rails when the room is being operated. The gear assembly may pinch or catch on loose clothing causing personal injury.**

**NOTE:** Install transit bars (if so equipped) on the slide-out room during storage and transportation.

## Operation



**Failure to act in accordance with the following may result in death, serious injury, coach or property damage.**

- Always make sure that the slide-out room path is clear of people and objects before and during operation of the slide-out room.
- Always keep away from the slide rails when the room is being operated. The gear assembly may pinch or catch on loose clothing causing personal injury. Keep stored items in compartment clear of slide-out motor mechanisms and wiring to prevent interference of slide-out operation.
- Install transit bars (if so equipped) on the slide-out room during storage and transportation.
- The Above Floor Sofa Slide is controlled by a switch mounted on the coach wall, normally located close to the entry door.

### Extending Slide-Out Room

1. Level Unit
2. Verify the battery is fully charged and hooked up to the electrical system.
3. Remove transit bars (if so equipped).
4. Press and hold the IN/OUT switch in the OUT position until room is fully extended and stops moving.
5. Release switch, which will lock the room into position.

**NOTE:** Only hold OUT switch until room stops.

### Retracting Slide-Out Room

1. Verify the battery is fully charged and hooked up to the electrical system.
2. Press and hold the IN/OUT switch in the IN position until the room is fully retracted and stops moving.
3. Release the switch. This will lock the room into position.

**NOTE:** Only hold IN switch until room stops.

4. Install the transit bars (if so equipped).

## Maintenance

### Preventative

The Above Floor Sofa Slide-out has been designed to require very little maintenance and has been static tested to over 2,500 continuous cycles without any noticeable wear to rotating or sliding parts. No grease or lubrication is necessary and in some situations may be detrimental to the environment and long term dependability of the system. To ensure the long life of your slide-out system, read and follow these few simple procedures.

### Electric

For optimum performance, slide-out system requires full battery current and voltage. The battery **MUST** be maintained at full capacity. Other than good battery maintenance, check the terminals and other connections at the battery, the control switch, and the electric motor for corrosion, and loose or damaged terminals. Check motor leads under the motor-home chassis. Since these connections are subject to damage from road debris, be sure they are in good condition.

**NOTE:** The Above Floor Sofa Slide-out is designed to operate as a negative ground system. A 12VDC system **MUST** maintain good wire connections. It is important that the electrical components have good ground connection. Over 90% of unit electrical problems are due to bad ground connections.



## Mechanical Maintenance

Although the system is designed to be almost maintenance free, inspect the slide-out for any visible signs of external damage after and before movement of the room. Remember to inspect inside the coach as well as the slide-out outside the coach.

**NOTE:** For long-term storage: It is recommended that the room be retracted.

**NOTE:** Visually inspect the Slide Floor and Drive Box Assemblies. Refer to Fig. 1 for location of rail assemblies. Check for excess build up of dirt or other foreign material; remove any debris that may be present.

**NOTE:** If the system squeaks or makes any noises it is permissible to apply a coat of lightweight oil to the drive shaft and roller areas but remove any excess oil so dirt and debris do not build up. DO NOT use grease.

## Troubleshooting

### Troubleshooting Introduction

The Above Floor Sofa Slide-out System is only one of four inter-related slide-out room system components. These four components are as follows: chassis, slide-out room, coach and Above Floor Sofa Slide-out System. Each one needs to function correctly with the others or misalignment problems will occur.

Every coach has its own personality and what may work to fix one coach may not work on another, even if the symptoms appear to be the same.

When something restricts room travel, system performances will be unpredictable. It is very important that slide rails, rack and pinion be free of contamination and allowed to travel freely the full distance or "STROKE." Debris build up during travel is an example of the type of contamination that may occur.

When beginning to troubleshoot the system, make sure the battery is fully charged, there are no visible signs of external damage to the actuator, motor or rails and that the motor is wired properly and all connections are secure.

You can adjust room extension by modifying the position of the rack gear on the slide floor rail to the pinion gear on the gear assembly.

During troubleshooting, remember, by changing, altering or adjusting one thing, it may affect something else. Be sure any changes do not create a new problem.

### Switch Related Problems:

- If room moves opposite from what the switch plate indicates, reverse the motor wires on the back of the switch. Wire size **MUST** be 10ga. min.

What Is Happening?	Why?	What Should Be Done?
Room doesn't move when switch is pressed	Restriction or obstruction inside or outside of unit	Check for and clear obstruction
	Low battery voltage, blown fuse, defective wiring	Check battery voltage and charge if needed. Find and check fuse, replace if blown. Check battery terminals and wiring. Look for loose, disconnected or corroded connectors.
	Excessive room drag	Check that transit bars are removed
Room starts to move and stops	Low battery voltage, blown fuse, defective wiring	Check battery voltage and charge if needed. Find and check fuse, replace if blown. Check battery terminals and wiring. Look for loose, disconnected or corroded connectors.
	Obstruction of room inside or outside	Check for and clear obstruction
Room chatters during operation	Teeth on gear drive broken or worn	Replace gear drive assembly
	Teeth on inner rail broken and worn	Replace inner rail assembly

## ⚠ CAUTION

**Always disconnect battery from system prior to manually operating system. Failure to disconnect battery can cause electricity to back feed through the motor and cause serious damage to the system as well as void the warranty.**

1. Accessing Out-Stop Assembly (Fig. 1).

**NOTE:** The slide-out out-stop assembly will be accessible from the inside of the unit. The slide-out motor and mechanism is accessible from the outside (Fig. 2).

**NOTE:** The gears can be stripped out if the room is manually retracted/extended to its fullest extent and the operator continues to rotate manual override. Any damage due to misuse of the Manual Override feature will disqualify any and all claims to the limited warranty.

2. With a second person assisting, one person **MUST** push and hold the manual override switch (COA Only) while the other person, using a  $\frac{5}{8}$ " wrench or socket/ratchet combination, rotates the hex head manual override (Figs. 3 and 4) to manually move the slide-out.

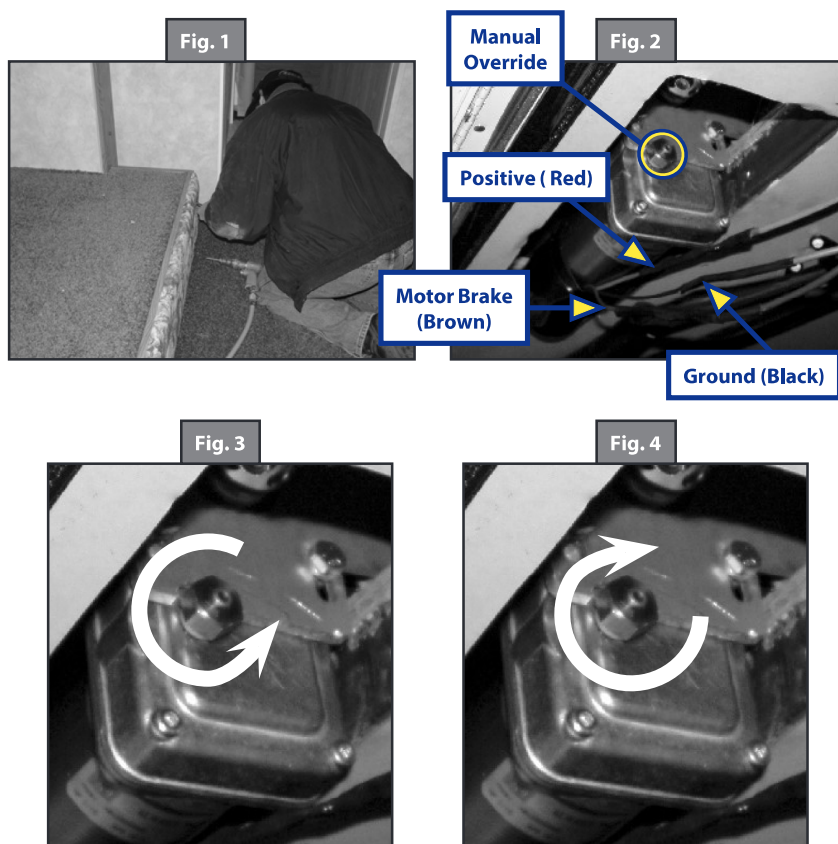

Room Adjustment

1. For Horizontal Adjustment, back both bolts out just enough to release tension.  
**NOTE:** In a Dual System, bolts **MUST** be loosened on both head stocks to adjust the room horizontally.
2. Adjust room to desired location.
3. Tighten bolts before operating room.
4. Loosen jam nut on the outside of the Out Stop Bracket (Fig. 6).
5. Adjust Stop Bolt to desired location.
6. Tighten jam nut.

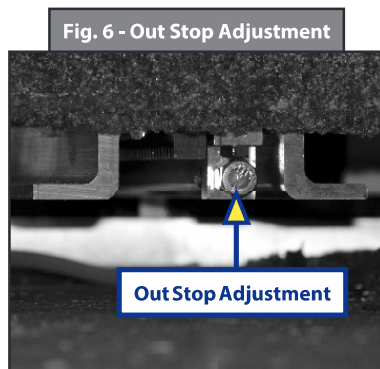
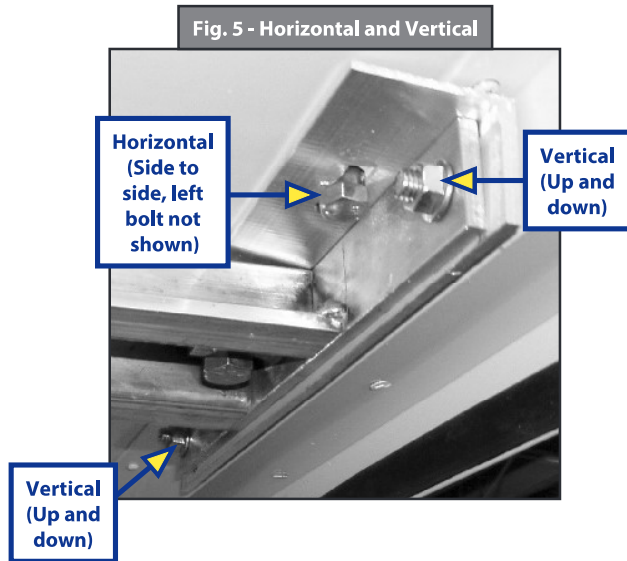

## SLIDE-OUT

**System Information**

The Electric Through Frame Slide-out System is a rack and pinion guide system, utilizing an electric ball screw actuator to move the room assembly. The motor drives the ball screw in a forward and backward motion to move the slide room in and out. The actuator comes equipped with an automatic clutching system. The Electric Slide-out System is designed to operate as a negative ground system.

**Safety Information**

**Failure to act in accordance with the following may result in death or serious personal injury.**

The Through Frame Slide-out System is intended for the sole purpose of extending and retracting the slide-out room. Its function should not be used for any other purpose or reason than to actuate the slide-out room. To use the system for any reason other than what it is designed for may result in death, serious injury or damage to the coach.

Before actuating the system, please keep these things in mind:

1. Parking locations should be clear of obstructions that may cause damage when the slide-out room is actuated.
2. Be sure all persons are clear of the coach prior to the slide-out room actuation.
3. Keep hands and other body parts away from slide-out mechanisms during actuation. Severe injury or death may result.
4. To optimize slide-out actuation, park coach on solid and level ground.

**Prior To Operation**

Prior to operating the Through Frame Slide-out System, follow these guidelines:

1. Coach should be parked on the most level surface available.
2. Leveling or stabilizing system should be actuated to ensure coach will not move during operation of slide-out system.
3. Be sure battery is fully charged.
4. Be sure to keep all persons and pets clear of slide-out system during operation.



**Always make sure that the slide-out room path is clear of people and objects before and during operation of the slide-out room. Always keep away from the slide rails when the room is being operated. The gear assembly may pinch or catch on loose clothing causing personal injury.**

**NOTE:** Install transit bars (if so equipped) on the slide-out room during storage and transportation.

## Operation

### Extending Slide-Out Room

1. Level Unit
2. Verify the battery is fully charged and hooked up to the electrical system.
3. Remove transit bars (if so equipped).
4. Press and hold the IN/OUT switch in the OUT position (Fig. 1B) until room is fully extended and stops moving.
5. Release switch, which will lock the room into position.

**NOTE:** Only hold OUT switch until room stops.

### Retracting Slide-Out Room

1. Verify the battery is fully charged and hooked up to the electrical system.
2. Press and hold the IN/OUT switch in the IN position (Fig. 1A) until the room is fully retracted and stops moving.
3. Release the switch. This will lock the room into position.

**NOTE:** Only hold IN switch until room stops.

4. Install the transit bars (if so equipped).

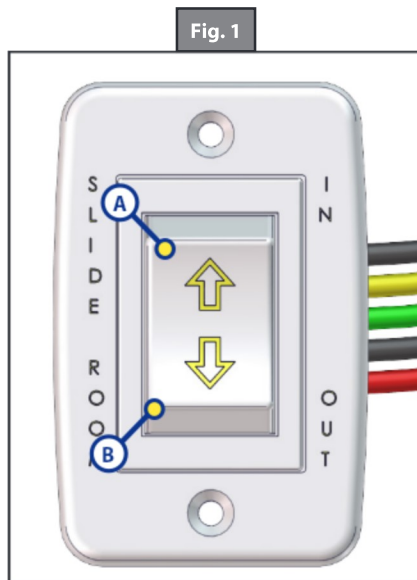

## Maintenance

### Inspection

After servicing the slide-out system in any way, be sure to check the following:

1. Slide-out stops are installed and adjusted properly.
2. Head assemblies are installed and adjusted properly.
3. System is mounted properly.
4. Cross shafts are mounted properly and clear all other components.
5. Gear packs function properly.
6. Manual override is accessible.
7. Outside seals compress when slide-out is retracted.
8. Inside seals compress when slide-out is extended.
9. Slide-out extends and retracts smoothly.
10. Both sides of slide-out are synchronized.
11. Any dirt or debris is cleaned from the interior or exterior of the coach.

The Electric Through Frame Slide-out System has been static tested to over 4,000 continuous cycles without any noticeable wear to rotating or sliding parts. It is recommended that when operating in harsh environments (road salt, ice build up, etc.) the moving parts be kept clean. They can be washed with mild soap and water. No grease or lubrication is necessary and in some situations may be detrimental to the environment and long term dependability of the system.

### Electrical System Maintenance

For optimum performance, the slide-out system requires full battery current and voltage. The battery **MUST** be maintained at full capacity. Other than good battery maintenance, check the terminals and other connections at the battery, the control switch, and the system for corrosion, and loose or damaged terminals. Check motor leads under the trailer chassis. Since these connections are subject to damage from road debris, be sure they are in good condition.

**NOTE:** The Electric Through Frame Slide-out System is designed to operate as a negative ground system. A negative ground system utilizes the chassis frame as a ground and an independent ground wire back to battery is necessary. It is important that the electrical components have good wire to chassis contact. To ensure the best possible ground, a star washer should be used. Over 90% of unit electrical problems are due to bad ground connections.

### Mechanical Maintenance

Although the system is designed to be almost maintenance free, actuate the room once or twice a month to keep the seals and internal moving parts lubricated. Check for any visible signs of external damage after and before movement of the travel trailer.

**NOTE:** For long-term storage: It is recommended that the room be closed (retracted).

## Adjustments

### Horizontal Adjustment

1. Loosen carriage bolts (Fig. 2A) on each bracket located at the end of each guide tube.
2. Room is ready to be positioned horizontally by pushing on the outside, sidewall or by using a prying device inserted into the opening between the room and coach.

**NOTE:** Use caution when using prying device so seals do not become damaged.

### Vertical Adjustment

1. Loosen 2 carriage bolts (Fig. 2A) on each bracket located at the end of each guide tube.
2. Loosen jam nut (Fig. 3A).
3. For vertical adjustment turn vertical adjustment bolt (Fig. 3B) up or down to locate room height.
4. Once room height is located, tighten carriage bolts (Fig. 2A) and jam nut (Fig. 3A).

### Synchronizing Room Travel

The Electric Through Frame Slide-out System room travel (both sides of the room traveling the same distance) can be adjusted with specially designed synchronizing bracket mounted on the passive slide tube. The passive slide tube is the one that is not powered. The active slide tube is the one that has the cylinder attached. If one side of the room fails to seal adjust as follows:

1. Extend the slide-out about halfway out.
2. Measure the active side from the "T"-molding on the slide-out back to the outside wall of the coach.
3. Then, measure the passive side in the same manner.
4. Loosen bolts (Fig. 2C) on top of the passive slide tube (Fig. 2B).
5. Push or pull room (on passive side) to align the passive side with the active side.
6. Tighten bolts (Fig. 2C) to secure the passive side position.
7. Retract room and run as normal.

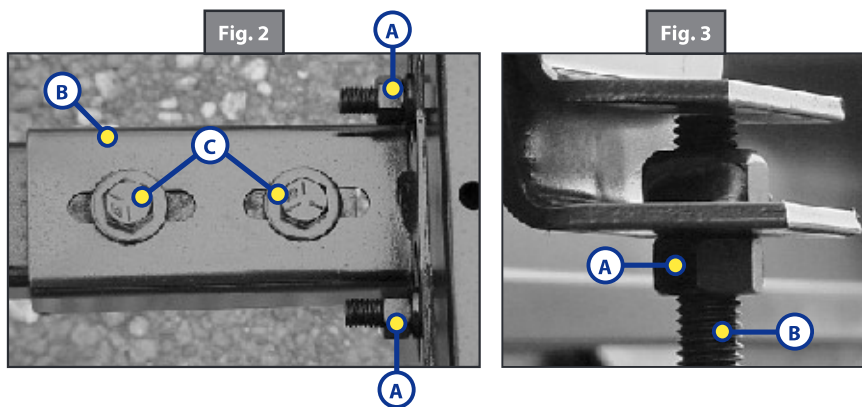



## Troubleshooting

### Troubleshooting Introduction

This troubleshooting chart outlines some common problems, their causes and possible corrective actions. If any part or serial number information is available, provide it to the service technician when asking for assistance.

The Electric Through Frame Slide-out System is only one of four interrelated slide-out room system components. These four components are: chassis, room, coach, and Slide-out System. Each one needs to function correctly with the others or misalignment problems will occur. Every travel trailer has its own personality and what may work to fix one trailer may not work on another even if the symptoms appear to be the same. When something restricts room travel, system performance will be unpredictable. It is very important that slide tubes be free of contamination and allowed to travel full distance (Stroke). Ice or mud buildup during travel is an example of a type of contamination that can occur. When you begin to troubleshoot the system, make sure the battery is fully charged, there are no visible signs of external damage to the system and that all connections are secure. During troubleshooting, remember that if you change something, that change may affect something else. Be sure any changes you make will not create a new problem. You can obtain additional information on the Electric Through Frame Slide-out System by visiting [www.lci.com/customerservice](http://www.lci.com/customerservice) or by calling 574-537-8900.

What Is Happening?	Why?	What Should Be Done?
Room doesn't move when switch is pressed.	Restriction or obstruction inside or outside of unit.	Check for and clear obstruction.
	Low battery voltage, blown fuse, defective wiring.	Check battery voltage and charge if needed. Find and check fuse, replace if blown. Check battery terminals and wiring. Look for loose, disconnected or corroded connectors.
Actuator motor runs but room does not move.	Actuator not attached to front mounting drive bracket.	Check jam nuts/nylock nuts. Be sure that they are properly tightened and adjusted.
	Bad motor or gear housing.	Replace motor.
Motor runs but room moves slowly.	Low battery voltage, poor ground, extremely low outdoor temperature.	Charge battery and check ground wire.
	Room is in a bind.	Check to see that room is properly adjusted.
Room stalls in mid-travel.	Actuator in a bind.	Crank manual override and move room short distance then retry electric switch to move room.
	Bad actuator.	Replace actuator if above instructions do not work.

### Manual Override

**NOTE:** Always disconnect battery from system prior to manually operating system. Failure to disconnect battery can cause electricity to backfeed through the motor and cause serious damage to the system as well as void the warranty.

The Electric Through Frame Slide-out comes with a Manual Override system. There are two different methods for manually extending and retracting the slide-out room. A crank handle extension can be used outside the chassis main rail at the crank extension with pin (Figs. 4-5). A socket and ratchet can be used inside the main frame on the hex head crank extension (Figs. 6-7).

### Manual Override - Outside Frame

Locate the crank extension with pin outside of the chassis main rail (Fig. 4). This is where the crank handle (standard fifth wheel landing gear crank handle) fits on (Fig. 5) to allow the manual extension/retraction of the room. Rotate the crank handle clockwise to retract and counterclockwise to extend slide-out. It is important to note that you DO NOT need to attempt to disengage the motor as the actuator is "manual ready." Just hook up and crank.



Use EXTREME CAUTION when extending and/or retracting room using the manual override feature. It is possible to operate the slide-out beyond the maximum extension and/or retraction and damage the slide components, slide room structure or trim components.

**NOTE:** The gears can be stripped out if the room is manually retracted/extended to its fullest extent and the operator continues to rotate the manual override. Any damage due to misuse of the Manual Override feature will disqualify any and all claims to the Limited Warranty.

Fig. 4

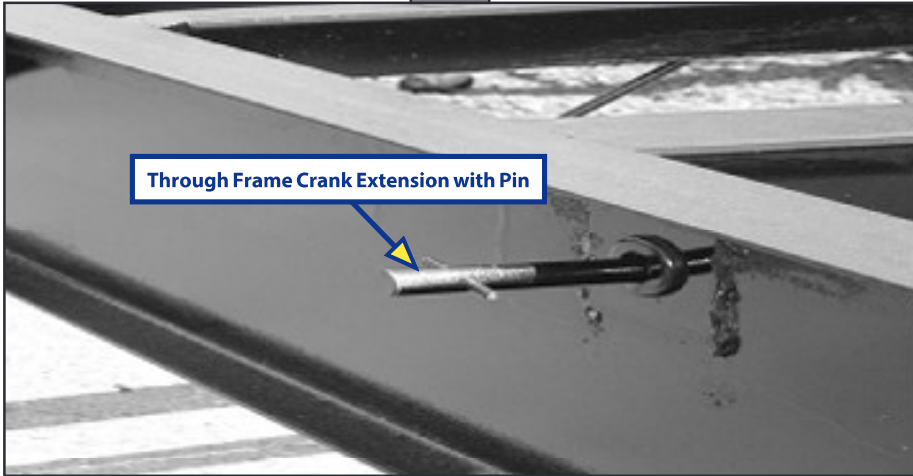
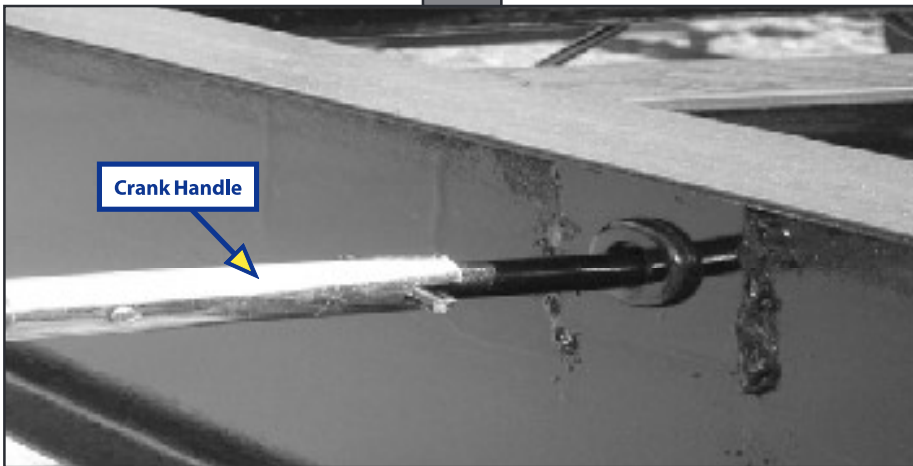

Fig. 5



### Manual Override - Inside Frame

Locate the hex head crank extension at the top of the actuator inside the chassis main frame (Fig. 6). Using a  $\frac{3}{4}$  socket and ratchet (Fig. 7), rotate the extension clockwise to retract the slide-out and counter clockwise to extend the slide-out. It is important to note that you DO NOT need to attempt to disengage the motor as the actuator is "manual ready."

**NOTE:** Use EXTREME CAUTION when extending and/or retracting room using the manual override feature. It is possible to operate the slide-out beyond the maximum extension and/or retraction and damage the slide components, slide room structure or trim components.

**NOTE:** The gears can be stripped out if the room is manually retracted/extended to its fullest extent and the operator continues to rotate the manual override. Any damage due to misuse of the Manual Override feature will disqualify any and all claims to the Limited Warranty.

Fig. 6

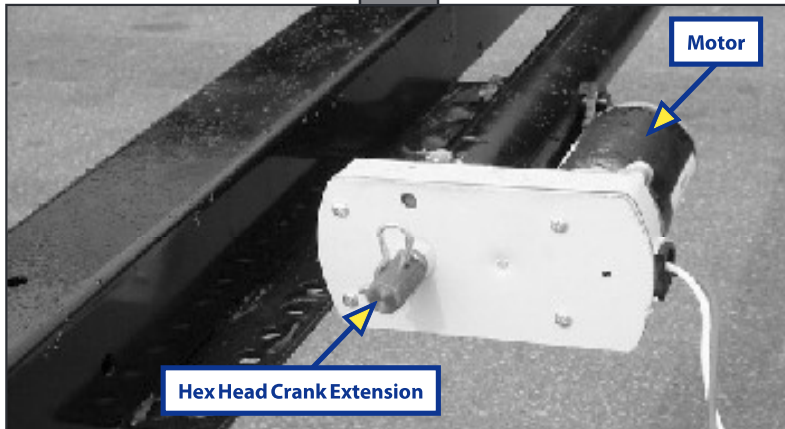
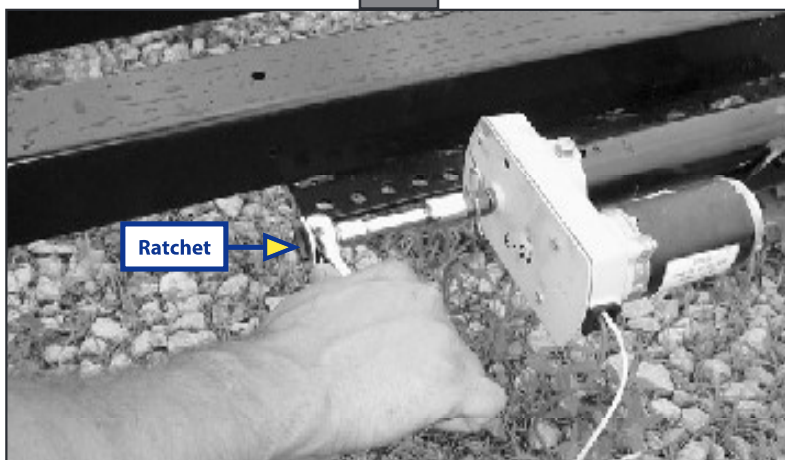
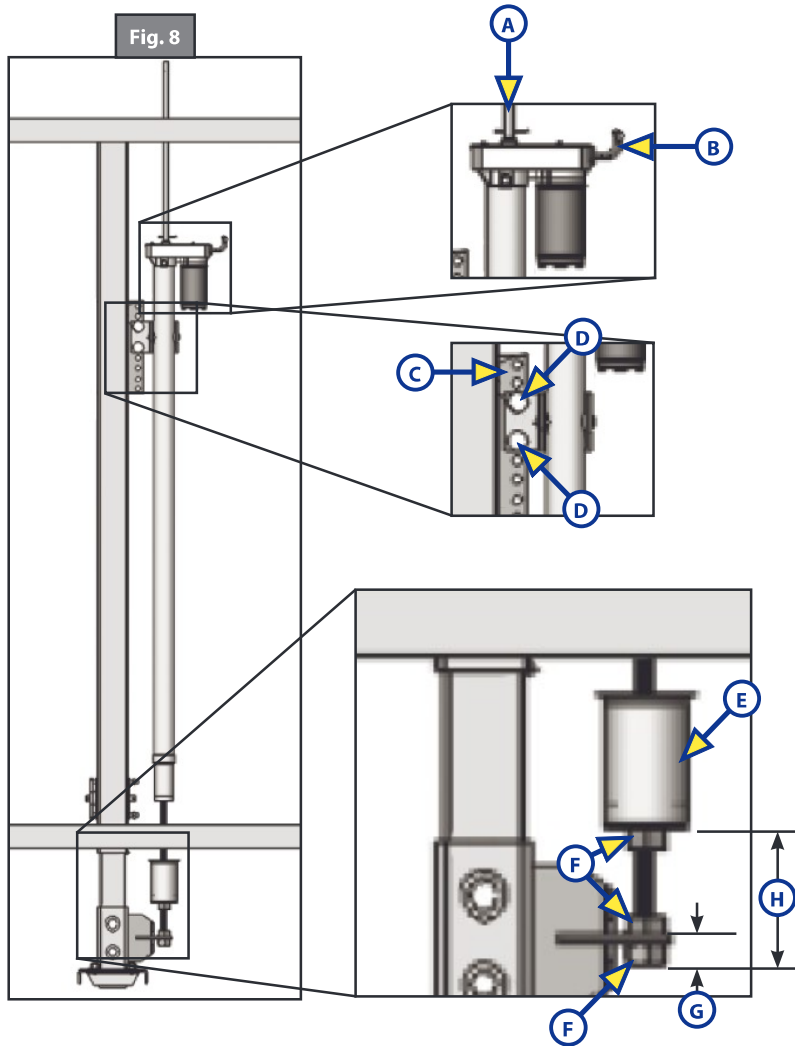

Fig. 7



### Removing and Replacing Actuator

1. Disconnect manual crank shaft (Fig. 8A) from end of motor assembly.
2. Disconnect motor wires from source (Fig. 8B).
3. Take measurements (Fig. 8G and 8H).
4. Remove all jam nuts (Fig. 8F) and stop can (Fig. 8E) from threaded shaft on actuator.
5. Take note of mounting bolt locations and remove mounting bolts (Fig. 8D).
6. After everything is disconnected, slide actuator out of frame. To replace with new actuator, follow previous directions in reverse.



Wiring Diagram

Fig. 9

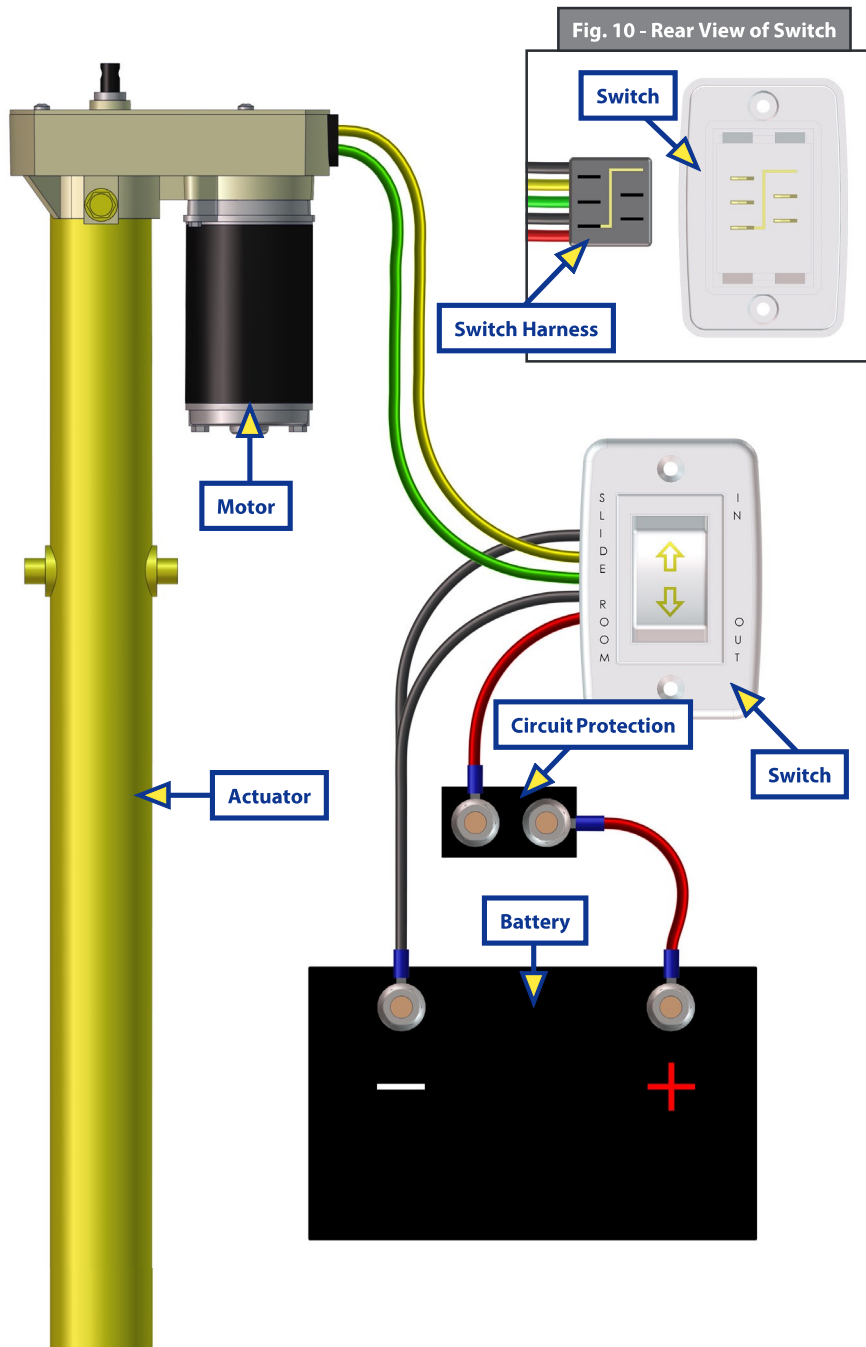

## SLIDE-OUT

**System Information**

The Hydraulic Through Frame Slide-out System is a rack and pinion guide system, utilizing a hydraulic cylinder to move the room assembly. The power unit drives the cylinder rod in a forward and backward motion to move the slide room in and out. The Hydraulic Through Frame Slide-out System is designed to operate as a negative ground system.

**Safety Information**

The “WARNING” symbol above is a sign that a service or maintenance procedure has a safety risk involved and may cause serious injury or death if not performed safely and within the parameters set forth in this manual.

Always wear eye protection when performing service or maintenance to the vehicle. Other safety equipment to consider would be hearing protection, gloves and possibly a full face shield, depending on the nature of the service.

This manual provides general service and maintenance procedures. Many variables can change the circumstances of the service procedure, i.e., the degree of difficulty involved in the service operation and the ability level of the individual performing the operation. This manual cannot begin to plot out procedures for every possibility, but will provide the general instructions for effectively servicing the vehicle. In the event the skill level required is too high or the procedure is too difficult, a certified technician should be consulted before performing the necessary service. Failure to correctly service the vehicle may result in death, serious injury or voiding the warranty. The owner’s manual for the unit may have more procedures for service and maintenance.



**Failure to act in accordance with the following may result in death, serious injury, coach or property damage.**

The Hydraulic Through Frame Slide-out System is intended for the sole purpose of extending and retracting the slide-out room. Its function should not be used for any other purpose or reason than to actuate the slide-out room. To use the system for any reason other than what it is designed for may result in damage to the coach and/or cause serious injury or even death. Before actuating the system, please keep these things in mind:

1. Parking locations should be clear of obstructions that may cause damage when the slide-out room is actuated.
2. Be sure all persons are clear of the coach prior to the slide-out room actuation.
3. Keep hands and other body parts away from slide-out mechanisms during actuation. Severe injury or death may result.
4. To optimize slide-out actuation, park coach on solid and level ground.

## Prior To Operation

Prior to operating the Hydraulic Through Frame Slide-out System, follow these guidelines:

1. Coach should be parked on the most level surface available.
2. Leveling or stabilizing system should be actuated to ensure coach will not move during operation of slide-out system.
3. Be sure battery is fully charged.
4. Be sure to keep all persons and pets clear of slide-out system during operation.



**Always make sure that the slide-out room path is clear of people and objects before and during operation of the slide-out room. Always keep away from the slide rails when the room is being operated. The gear assembly may pinch or catch on loose clothing causing personal injury.**

**NOTE:** Install transit bars (if so equipped) on the slide-out room during storage and transportation.

## Operation

### Extending Slide-Out Room

1. Level the Unit.
2. Verify the battery is fully charged and hooked up to the electrical system.
3. Remove transit bars (if so equipped).
4. Press and hold the IN/OUT switch (Fig.1) in the OUT position (Fig.1B) until room is fully extended and stops moving.
5. Release switch, which will lock the room into position.

**NOTE:** Only hold OUT switch until room stops.

### Retracting Slide-Out Room

1. Verify the battery is fully charged and hooked up to the electrical system.
2. Press and hold the IN/OUT switch (Fig.1) in the IN position (Fig.1A) until the room is fully retracted and stops moving.
3. Release the switch. This will lock the room into position.

**NOTE:** Only hold IN switch until room stops.

4. Install the transit bars (if so equipped).





## Maintenance

### Inspection

After servicing the slide-out system in any way, be sure to check the following:

1. Slide-out stops are installed and adjusted properly.
2. Head assemblies are installed and adjusted properly.
3. System is mounted properly.
4. Cross shafts are mounted properly and clear all other components.
5. Gear packs function properly.
6. Manual override is accessible.
7. Outside seals compress when slide-out is retracted.
8. Inside seals compress when slide-out is extended.
9. Slide-out extends and retracts smoothly.
10. Both sides of slide-out are synchronized.
11. Any dirt or debris is cleaned from the interior or exterior of the coach.

The Hydraulic Through Frame Slide-out System has been static tested to over 4,000 continuous cycles without any noticeable wear to rotating or sliding parts. It is recommended that when operating in harsh environments (road salt, ice build up, etc.) the moving parts be kept clean. They can be washed with mild soap and water. No grease or lubrication is necessary and in some situations may be detrimental to the environment and long term dependability of the system.

### Electrical Maintenance

For optimum performance, the slide-out system requires full battery current and voltage. The battery **MUST** be maintained at full capacity. Other than good battery maintenance, check the terminals and other connections at the battery, the control switch, and the system for corrosion, and loose or damaged terminals. Check motor leads under the trailer chassis. Since these connections are subject to damage from road debris, be sure they are in good condition.

**NOTE:** The Hydraulic Through Frame Slide-out System is designed to operate as a negative ground system. A negative ground system utilizes the chassis frame as a ground and an independent ground wire back to the battery is necessary. It is important that the electrical components have good wire to chassis contact. To ensure the best possible ground, a star washer should be used. Over 90% of unit electrical problems are due to bad ground connections.

### Mechanical Maintenance

Although the system is designed to be almost maintenance free, actuate the room once or twice a month to keep the seals and internal moving parts lubricated. Check for any visible signs of external damage after and before movement of the travel trailer.

For long-term storage: It is recommended that the room be closed (retracted).

### Fluid Recommendation

The Lippert Electronic Leveling System is pre-filled, primed and ready to operate direct from the manufacturer. Type "A" Automatic Transmission Fluid (ATF) is utilized and will work. ATF with Dexron III® or Mercon 5® or a blend of both is recommended by Lippert Components, Inc.

In colder temperatures (less than 10° F) the jacks may extend and retract slowly due to the fluid's molecular nature. For cold weather operation, fluid specially formulated for low temperatures may be desirable. For a list of approved fluid specifications, see TI-188.

1. Remove Breather/Fill Cap (Fig. 2).
2. Pour ATF into Breather/Fill opening.

**NOTE:** Do not allow any contamination into reservoir during fill process.

**NOTE:** Standard reservoir holds approximately 2 quarts (1.89 liters) of ATF.

3. Fill to within ½" of top.
4. Replace Breather/Fill cap when finished.

**NOTE:** System is self-purging. By simply cycling the system 2-3 times, any air in the system will be forced back to the reservoir and out of the Breather/Fill cap.

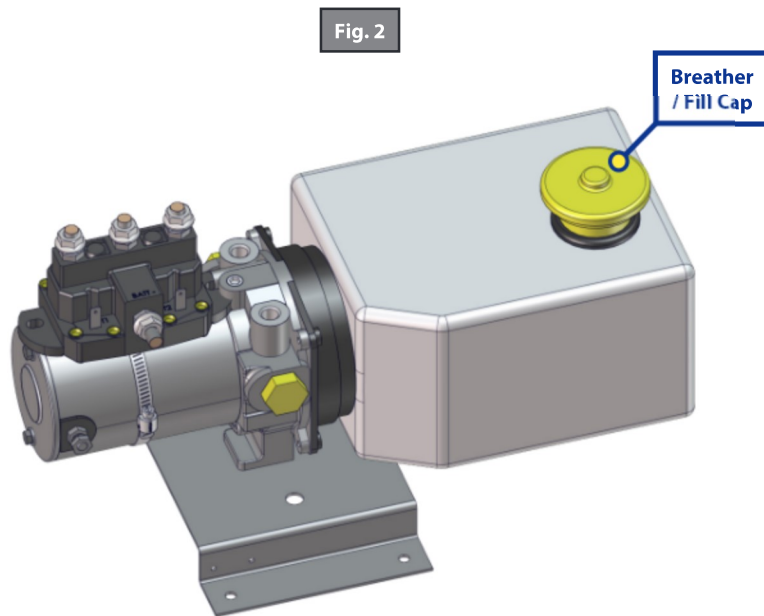

## Adjustments

**NOTE:** All slide-out room adjustments **MUST** be performed by certified service technicians. Adjustments made by non-certified persons may void any and all warranty claims.

### Adjusting The Room To Seal In The IN Position

1. Locate cylinder coming through the frame.
2. Run room partially out.
3. Hold jam nut (Fig. 3A) in place with wrench.
4. Adjust Nylock nut (Fig. 3C) towards the bracket if the room does not seal. Adjust the Nylock nut (Fig. 3C) away from the bracket if the room is too tight and damages the fascia.

**NOTE:** Make small adjustments, running the room in after each adjustment until proper seal is achieved.

### Adjusting The Room To Seal In The OUT Position

1. Locate cylinder coming through the frame.
2. Extend room completely out.
3. Check the inside fascia and seal positioning.
4. Partially retract room.
5. Loosen and back off jam nut (Fig. 3A) from nut (Fig. 3B) to give nut (Fig. 3B) room for adjustment.
6. Adjust nut (Fig. 3B) away from the bracket if the room extends too far and damages the inside fascia. Adjust nut (Fig. 3B) towards the bracket if the room does not seal.

**NOTE:** Make small adjustments, running the room out after each adjustment until proper seal is achieved.

7. Tighten jam nut (Fig. 3A) to nut (Fig. 3B).

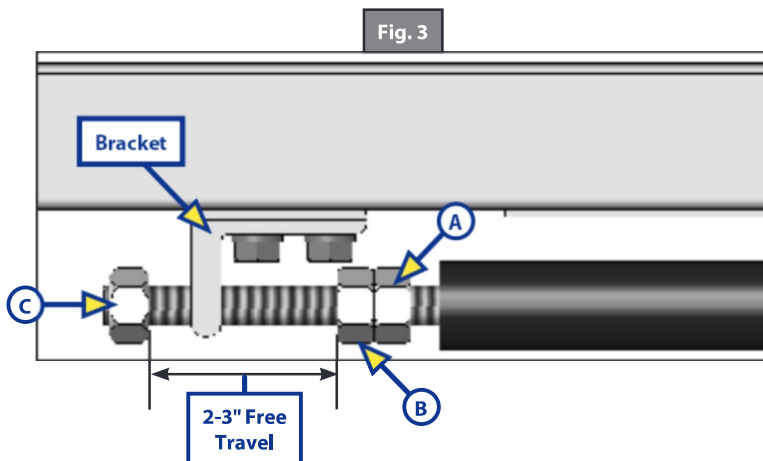

### Horizontal Adjustment

1. Loosen carriage bolts (Fig. 4A) on each bracket located at the end of each guide tube.
2. Room is ready to be positioned horizontally by pushing on the outside, sidewall or by using a prying device inserted into the opening between the room and coach.

**NOTE:** Use caution when using prying device so seals do not become damaged.

### Vertical Adjustment

1. Loosen 2 carriage bolts (Fig. 4A) on each bracket located at the end of each guide tube.
2. Loosen jam nut (Fig. 5A).
3. For vertical adjustment turn vertical adjustment bolt (Fig. 5B) up or down to locate room height.
4. Once room height is located, tighten carriage bolts (Fig. 4A) and jam nut (Fig. 5A).

### Synchronizing Room Travel

The Hydraulic Through Frame Slide-out System room travel (both sides of the room traveling the same distance) can be adjusted with specially designed synchronizing bracket mounted on the passive slide tube. The passive slide tube is the one that is not powered. The active slide tube is the one that has the cylinder attached. If one side of the room fails to seal adjust as follows:

1. Extend the slide-out about halfway out.
2. Measure the active side from the "T"-molding on the slide-out back to the outside wall of the coach.
3. Then, measure the passive side in the same manner.
4. Loosen bolts (Fig. 4C) on top of the passive slide tube (Fig. 4B).
5. Push or pull room (on passive side) to align the passive side with the active side.
6. Tighten bolts (Fig. 4C) to secure the passive side position.
7. Retract room and run as normal.

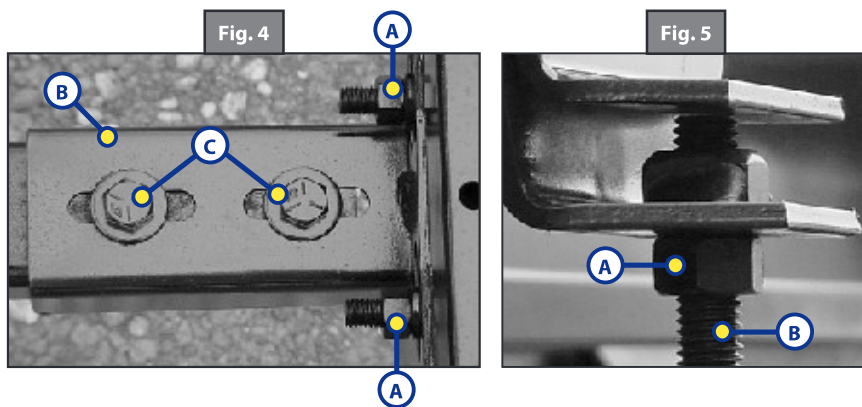

## Troubleshooting

### Manual Override

The Hydraulic Through Frame Slide-out System can be run with an auxiliary power device like an electric or cordless drill. In the event of electrical or system failure, this manual method of extending and retracting the slide-out room can be used. A standard hand-held drill is all that is required. A standard 38" room will take approximately 45 seconds to retract. See the instructions below.

1. Remove protective label (Fig. 6A).
2. Using a standard hex bit and auxiliary drive device (cordless or electric drill), insert hex bit into coupler found under protective label (Fig. 7).
3. Run drill counterclockwise to extend slide-out room and clockwise to retract slide-out room.

Fig. 6

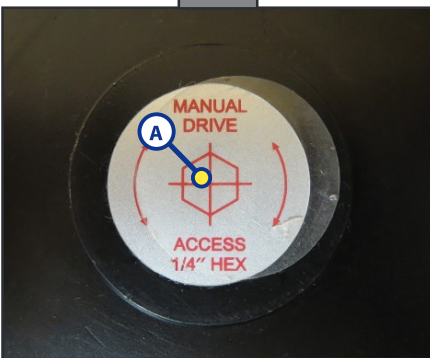
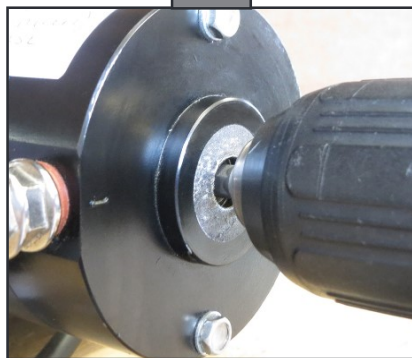

Fig. 7



### Motor Unit

Before attempting to troubleshoot the power unit, make sure an adequate power source is available. The unit batteries should be fully charged or the unit should be plugged into AC service with batteries installed. Do not attempt to troubleshoot the power unit without assuring a full 12V DC charge.

The following tests require only a DC voltmeter (or DC test light) and a jumper lead.

1. Attach voltmeter (or test light) leads to the negative and positive switch terminals on back of wall switch. Does the meter indicate 12VDC?

If **YES**, see **Step 2**; if **NO** see **Step 3**.

2. If **YES**, then at the motor, check the incoming leads to 12VDC (if necessary, disconnect leads at wire splices). Does meter indicate 12VDC? If **YES**, power unit needs to be replaced. The motor is not field serviceable. **DO NOT ATTEMPT TO REPAIR**. If **NO**, inspect all wires and connections between the wall switch and the motor. Repair connections as necessary. Recheck as in **Step 1**.
3. If **NO**, inspect all connections between battery and switch. Inspect any and all breakers, relays and fuses. Recheck as above in **Step 1**.

Since there are no field serviceable parts in the motor of the 12VDC motor, electrical troubleshooting and service is limited to replacing only those components as previously outlined.

**NOTE:** Thorough inspection of wiring and connections is the only other electrical service that can be performed.

What Is Happening?	Why?	What Should Be Done?
Room doesn't move when switch is pressed	Restriction or obstruction inside or outside of unit	Check for and clear obstruction
	Low battery voltage, blown fuse, defective wiring	Check battery voltage and charge if needed. Find and check fuse, replace if blown. Check battery terminals and wiring. Look for loose, disconnected or corroded connectors.
	Excessive room drag	Check that transit bars are removed
Power unit runs but room does not move	Motor turns, room does not move	Check that transit bars are removed
	Broken gear on drive shaft	Replace gear drive assembly
	Broken gear in gearbox	Replace motor/gearbox assembly
	Bad motor or gearbox	Replace motor/gearbox assembly
Power unit runs but room moves slowly	Low battery, poor ground, extremely low outdoor temperature	Charge battery and check ground wire
	Room is in a bind	Adjust to proper room setting
	Incorrect height adjustment	Check for proper room height
Room starts to move and stops	Low battery voltage, blown fuse, defective wiring	Check battery voltage and charge if needed. Find and check fuse, replace if blown. Check battery terminals and wiring. Look for loose, disconnected or corroded connectors.
	Obstruction of room inside or outside	Check for and clear obstruction
Room chatters during operation	Teeth on gear drive broken or worn	Replace gear drive assembly
	Teeth on inner rail broken and worn	Replace inner rail assembly

Wiring Diagram

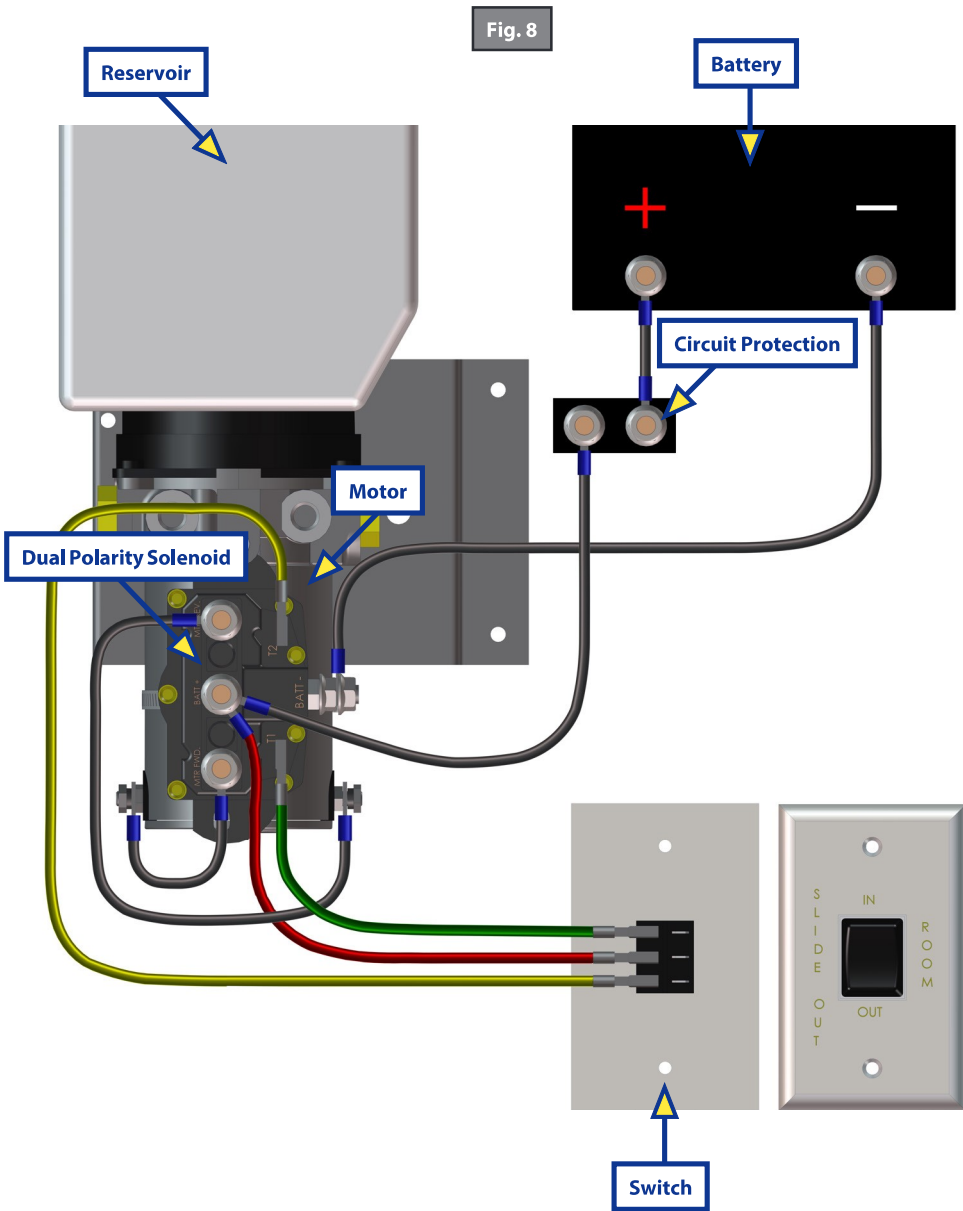

### Cylinder Port Locations

Fig. 9 - Standard Cylinder



Fig. 10 - Trunnion Cylinder

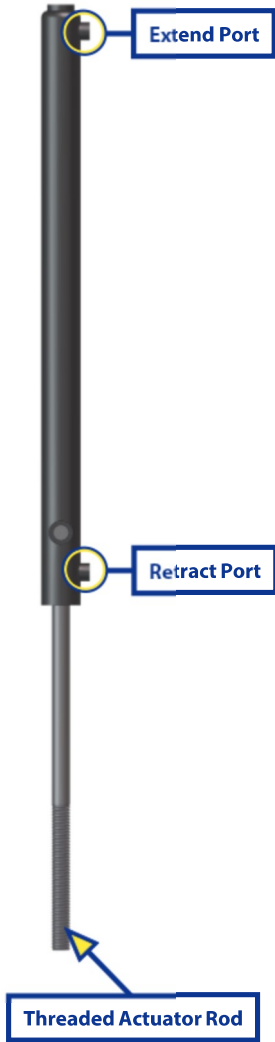







## LEVELING AND STABILIZATION

**System Information**

Level-Up® is an Automatic Leveling system. This system is equipped with 14K aluminum landing gear and 8K aluminum leveling jacks. The jacks in the Level-Up® system work in pairs.

**Safety Information**

-  Be sure to park the unit on solid, level ground.
-  Ensure all jack landing locations are cleared of debris and obstructions and also free of depressions.
-  When parking the unit on extremely soft surfaces, utilize load distribution pads under each jack.
-  People and pets should be clear of unit while operating leveling system.
-  Be sure to keep hands and other body parts clear of fluid leaks. Oil leaks in the Leveling System may be under high pressure and can cause serious skin-penetrating injuries.



**Lippert Components Inc. recommends that a trained professional be employed to change the tires on the unit. Ensure that the unit is properly supported with jack stands, or other adequate devices, under the frame of the unit prior to commencing any service or repair procedure. Any attempts to change the tires or perform other service while unit is supported solely by the LCI Level-Up® with Automatic Leveling System could result in death, serious injury, unit or property damage.**

## Touch Pad Diagram

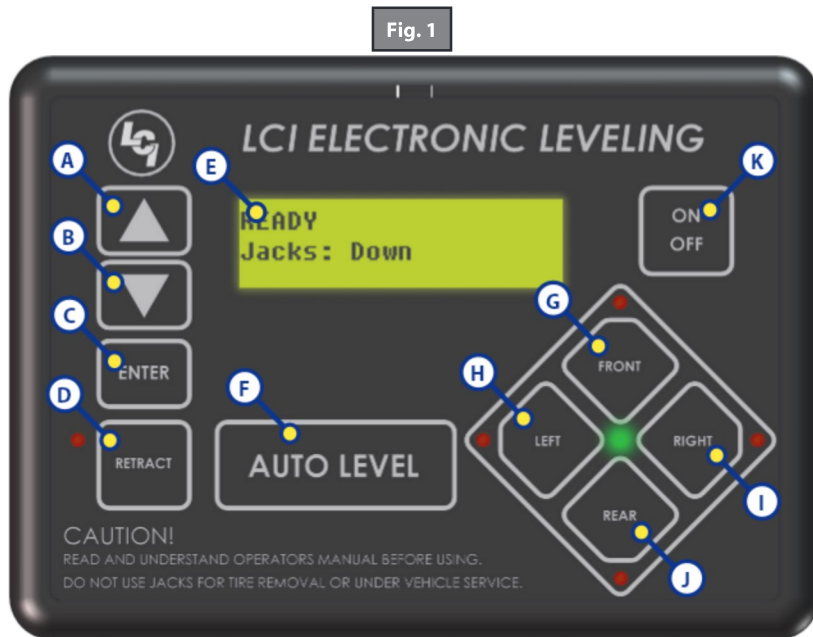

Callout	Description
A	Up Arrow - Scrolls up through the menu on LCD.
B	Down Arrow - Scrolls down through the menu on LCD.
C	Enter - Activates modes and procedures indicated on LCD.
D	Retract - Places leveling system into retract mode - Manual mode ONLY.
E	LCD Display - Displays procedures and results.
F	Auto Level - Places leveling system into auto level mode.
G	Front Button - Activates both front jacks.
H	Left Button - Activates left leveling jack(s) in manual mode.
I	Right Button - Activates right leveling jack(s) in manual mode.
J	Rear Button - Activates leveling jacks in manual mode.
K	Power Button - Turns leveling system on and off.

## Prior To Operation

The leveling system shall only be operated under the following conditions:

1. The unit is parked on a reasonably level surface.
2. Be sure all persons, pets and property are clear of the unit while LCI Level-Up® Automatic System is in operation.
3. Ensure the battery of the unit is fully charged or that the unit is plugged into shore power prior to attempting to operate the system. Level-Up® requires a minimum of 12 VDC from the battery for proper operation.

## Operation

### Basic Jack Operation

#### 1. Landing gear Jacks

Landing gear jacks can be operated any time the system is "ON" but NOT in the "AUTO MODE." By pushing the "FRONT" button (Fig. 1G), both front or landing gear jacks can be extended. If the touch pad is put in the "RETRACT" mode, indicated by the orange illuminated LED next to the "RETRACT" button (Fig. 1D), the front jacks can be retracted together by pushing the "FRONT" button.

#### 2. Level-Up® jacks

The Level-Up® jacks operate when the "AUTO MODE" is activated or the touch pad is in the "MANUAL MODE." Once system is in "MANUAL MODE," pressing the "REAR" button (Fig. 1J) will extend all Level-Up® jacks at the same time. Press the "LEFT" or "RIGHT" buttons (Fig. 1H and 1I) to operate Level-Up® jacks on the left or right side of the unit, respectively. 5th Wheel Operation

### Unhitching Instructions

1. Push touch panel "ON/OFF," (Fig. 1K) to turn system on. LCD Screen (Fig. 1E) lights up.
2. LCD will display status ... "NOT LEVEL JACKS: UP" (Fig. 2A).

**NOTE:** Orange directional lights (Fig. 2B) may come on, indicating the current disposition of the unit.

3. Push "FRONT" button (Fig. 1G) to extend landing gear jacks and lift front of unit to take the weight of the 5th wheel off of the hitch.
4. Uncouple the 5th wheel connection on the tow vehicle.
5. Pull tow vehicle away and park at a safe distance.

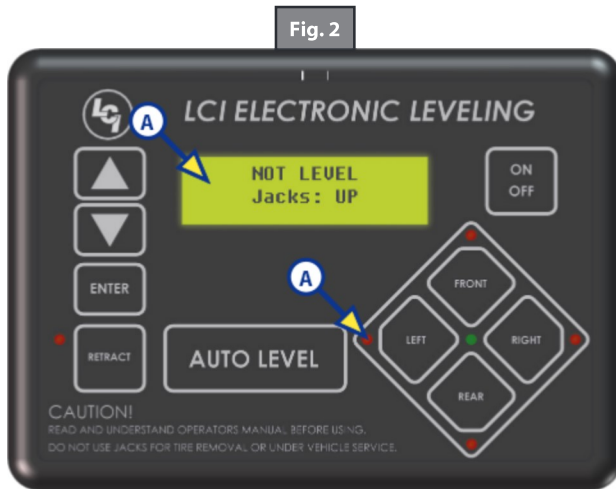

### Auto Level

**NOTE:** Prior to unhitching from the tow vehicle, ensure unit is parked on a level surface and chock the tires of the unit.

1. After unhitching from tow vehicle press "AUTO LEVEL" (Fig. 1F).

**NOTE:** Pressing any button during an Auto Level sequence will abort the auto leveling cycle.

**NOTE:** In order for hitch recognition feature to function, the auto level sequence **MUST** be started with the front of the unit above level.

### Auto Level Sequence

1. Front landing gear retract, lowering the front of the unit below level, stopping, then lifting the front end to level the unit front to back.
2. The left side leveling jack(s) extend and raise the roadside of the unit.
3. The right side leveling jack(s) extend and raise the curbside of the unit, beginning side to side leveling.
4. The front landing gear extend to complete the leveling cycle.

**NOTE:** Additional left to right or front to back leveling may occur if the controller deems necessary.

**NOTE:** If the auto level sequence does not happen as stated above, check to ensure proper manual function in all zones.

### Hitch Recognition

1. Turn on touch pad.
2. Press the "LEFT" and "RIGHT" buttons simultaneously (Fig. 1H and 1I).
3. The front of the unit will raise to the height where the auto level sequence was started.

**NOTE:** If the auto level sequence was started with the front of the unit in a below level condition, the Hitch Recognition will not function and the LCD will display "Feature Disabled." In order for the hitch recognition feature to function, the auto level sequence **MUST** be started with the front of the unit above level.

4. Connect tow vehicle and make sure 5th wheel and hitch are connected and locked.
5. Push "UP" arrow (Fig. 1A) until "AUTO RETRACT" appears in LCD screen.
6. Push "ENTER" (Fig. 1C). System will immediately retract all jacks.

## Travel Trailer Operation

### Unhitching Instructions

**NOTE:** Prior to unhitching from the tow vehicle, ensure unit is parked on a level surface and chock the tires of the unit.

1. Push "ON/OFF" button (Fig. 1K) to turn system "ON" (green light).
2. Push "UP" (Fig. 1A) or "DOWN" arrow (Fig. 1B) to scroll through features to "MANUAL MODE" in display.
3. Push "ENTER" (Fig. 1C).
4. Push "FRONT" button (Fig. 1G) to extend front jacks to the ground until the trailer is unhitched from the tow vehicle.

**NOTE:** The Power Tongue Jack should only be used when storing the trailer.

### Auto Level

**NOTE:** The Power Tongue Jack MUST be retracted prior to starting auto level sequence (Fig. 3 shows the LCD alert).

1. After unhitching from tow vehicle press "Auto Level" (Fig. 1F).

**NOTE:** Pressing any button during an Auto Level sequence will abort the auto leveling cycle.

**NOTE:** In order for hitch recognition feature to function, the auto level sequence **MUST** be started with the front of the unit above level.



### Auto Level Sequence

1. Front jacks retract, lowering the front of the unit below level, stopping, then lifting the front end to level the unit front to back.
2. The rear left side leveling jack extends and raises the roadside of the unit.
3. The rear right side leveling jack extends and raises the curbside of the unit, beginning side to side leveling.
4. The front jacks extend to complete the leveling cycle.

**NOTE:** Additional left to right or front to back leveling may occur if the controller deems necessary.

**NOTE:** If the auto level sequence does not happen as stated above, check to ensure proper manual function in all zones.

### Hitch Recognition

1. Turn on touch pad.
2. Press the left and right buttons simultaneously (Fig. 1H and 1I).
3. The front of the unit will raise to the height where the auto level sequence was started.

**NOTE:** If the auto level sequence was started with the front of the unit in a below level

condition, the Hitch Recognition will not function and the LCD will display "Feature Disabled." In order for hitch recognition feature to function, the auto level sequence **MUST** be started with the front of the unit above level.

4. Connect tow vehicle and make sure travel trailer and hitch are connected and locked.
5. Push "UP" arrow until "AUTO RETRACT" appears in LCD screen.
6. Push "ENTER." System will immediately retract all jacks.

## Manual Operation

1. Front landing gear (5th Wheels) or Front jacks (Travel Trailers)

**NOTE:** The landing gear or front jacks will operate manually any time system is "ON" except in "AUTO MODE."

- A. Push "ON/OFF" (Fig. 1K) to turn system on.
- B. Push "UP" arrow (Fig. 1A) once or until screen reads "MANUAL MODE" (Fig. 4).
- C. Push "ENTER" (Fig. 1C) once while screen reads "MANUAL MODE" (Fig. 4).
- D. Push "FRONT" (Fig. 1G) to extend front landing gear or front jacks.
- E. Push "RETRACT" (Fig. 1D) and orange LED (Fig. 5) comes on.
- F. Push "FRONT" (Fig. 1G) to retract front landing gear or front jacks.

**NOTE:** If orange LED (Fig. 5) is on, landing gear or jacks will retract. If orange LED (Fig. 5) is off, landing gear or jacks will extend.

- G. Push "ON/OFF" to turn system off.
  - H. After 3 minutes system will turn off by itself.
2. Level-Up® jacks - EXTEND
    - A. Turn "ON/OFF" button "ON."



- B. Push scroll arrow to display "MANUAL MODE" (Fig. 4).
- C. Push "ENTER" button, "MANUAL MODE" displayed (Fig. 4).

**NOTE:** By pushing "RIGHT," passenger side Level-Up® jacks operate. By pushing "LEFT," driver side Level-Up® jacks operate.

3. Level-Up® jacks - RETRACT

- A. Push "RETRACT" and orange LED (Fig. 5) will come on.
- B. Push "REAR" to retract all Level-Up® jacks.
- C. To extend, the "RETRACT" light (Fig. 5) should be off.

**NOTE:** The side to side movement in manual mode is limited to 5° of tilt.

## Zero Point Calibration

1. Turn "ON/OFF" button (Fig. 1K) on.
2. Push "FRONT" button (Fig. 1G) 10 times.
3. Push "REAR" (Fig. 1J) button 10 times.
4. Control will flash and beep, LCD will say "ZERO POINT CALIBRATE."
5. To memorize this level condition, press "ENTER" (Fig. 1C).
6. LCD will say "ZERO POINT STABILITY SUCCESSFULLY SET."
7. The control will then turn off.

## Maintenance

1. Each month, check that the fluid level is within ¼" of the fill spout lip while jacks and slide-outs are fully retracted.

**NOTE:** Always fill the reservoir with the jacks and slide-outs in the fully retracted position. Filling reservoir when jacks and slide-outs are extended will cause reservoir to overflow into its compartment when jacks and slide-outs are retracted.

2. Inspect and clean all power unit electrical connections prior to the first use of the unit of the season and prior to storing the unit. If corrosion is evident, clean all corrosion with a wire brush and apply dielectric grease to the connections.
3. Remove dirt and road debris from jacks as needed.
4. If jacks are down for extended periods, it is recommended to spray exposed leveling jack rods with a silicone lubricant every three months for protection. If the unit is located in a salty air environment, it is recommended to spray the rods every 4 to 6 weeks.

## Troubleshooting

### Error Display In LCD Screen

**NOTE:** To clear Error Code, push "ENTER" - If error remains, the code will appear again.

LCD Message	What's Happening?	A. What Should Be Done?
"EXCESS ANGLE"	Unsecured controller. Uneven or sloped site.	Check and secure controller placement. Relocate the unit.
"BAD CALIBRATION"	Unit zero point was not set correctly.	Reset zero point. See "Calibration."
"FEATURE DISABLED"	Front of unit below level when starting Auto Level process.	Raise front of unit above level and restart Auto Level process.
"LOW VOLTAGE"	Bad connection or wiring. Discharged or bad battery.	Check wiring - repair or replace. Test battery voltage under load - charge or replace.
"OUT OF STROKE"	Unsecured controller. Uneven or sloped site.	Check and secure controller placement. Relocate the unit.
"EXTERNAL SENSOR"	Bad connection or wiring.	Replace or repair connection to rear remote sensor.
"JACK TIME OUT"	System could not level in expected time.	Check for obstructions, leaks, fluid level and voltage to power unit motor under load.
"AUTO LEVEL FAILURE"	Unsecured controller. Voltage drop.	Check and secure controller placement. Test battery voltage under load - charge or replace.

### Manual Override

The LCI Level-Up® Automatic Leveling System can be manually operated with an electric drill. In the event of electrical or system failure, this manual method of extending and retracting the jacks can be used. See the instructions below.

**NOTE:** Unhook the power unit motor from the power source prior to attempting the manual override procedure.

1. Locate the valves that are paired with the landing gear or leveling jack to be manually overridden.
  - A. Landing Gear - Valve located on the landing gear (Fig. 6).
  - B. Leveling Jacks - Valve located on manifold (Fig. 7).
2. Using a  $\frac{5}{32}$ " hex wrench, open the valve by turning the manual override set screw clockwise (Fig. 8A).
3. Remove protective label (Fig. 9A) from power unit to reveal the manual override coupler.
4. Using an electric drill with a  $\frac{1}{4}$ " hex bit, insert the hex bit into the manual override coupler to manually operate the Level-Up system (Fig. 10).
  - A. Run the drill forward (clockwise) to retract the landing gear or leveling jack (Fig. 10A).
  - B. Run the drill in reverse (counterclockwise) to extend the landing gear or leveling jack (Fig. 10B).
5. Be sure to turn the manual override set screw on the valve (Fig. 11A) back to the counterclockwise position after extending or retracting the landing gear or leveling jack.

Fig. 6

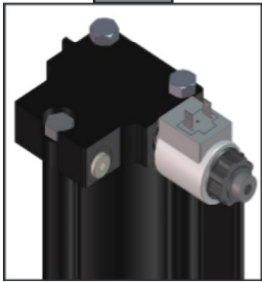

Fig. 7

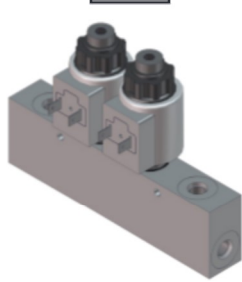

Fig. 8

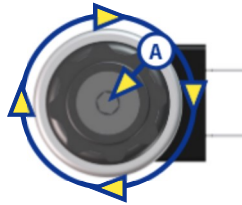

Fig. 9

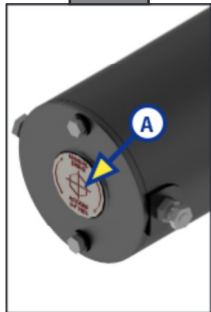

Fig. 10

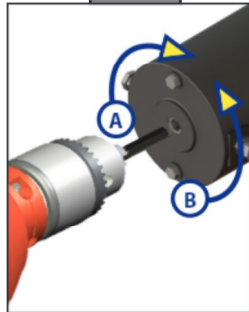
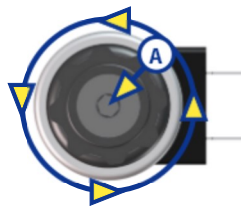

Fig. 11





Wiring Diagram

Fig. 12

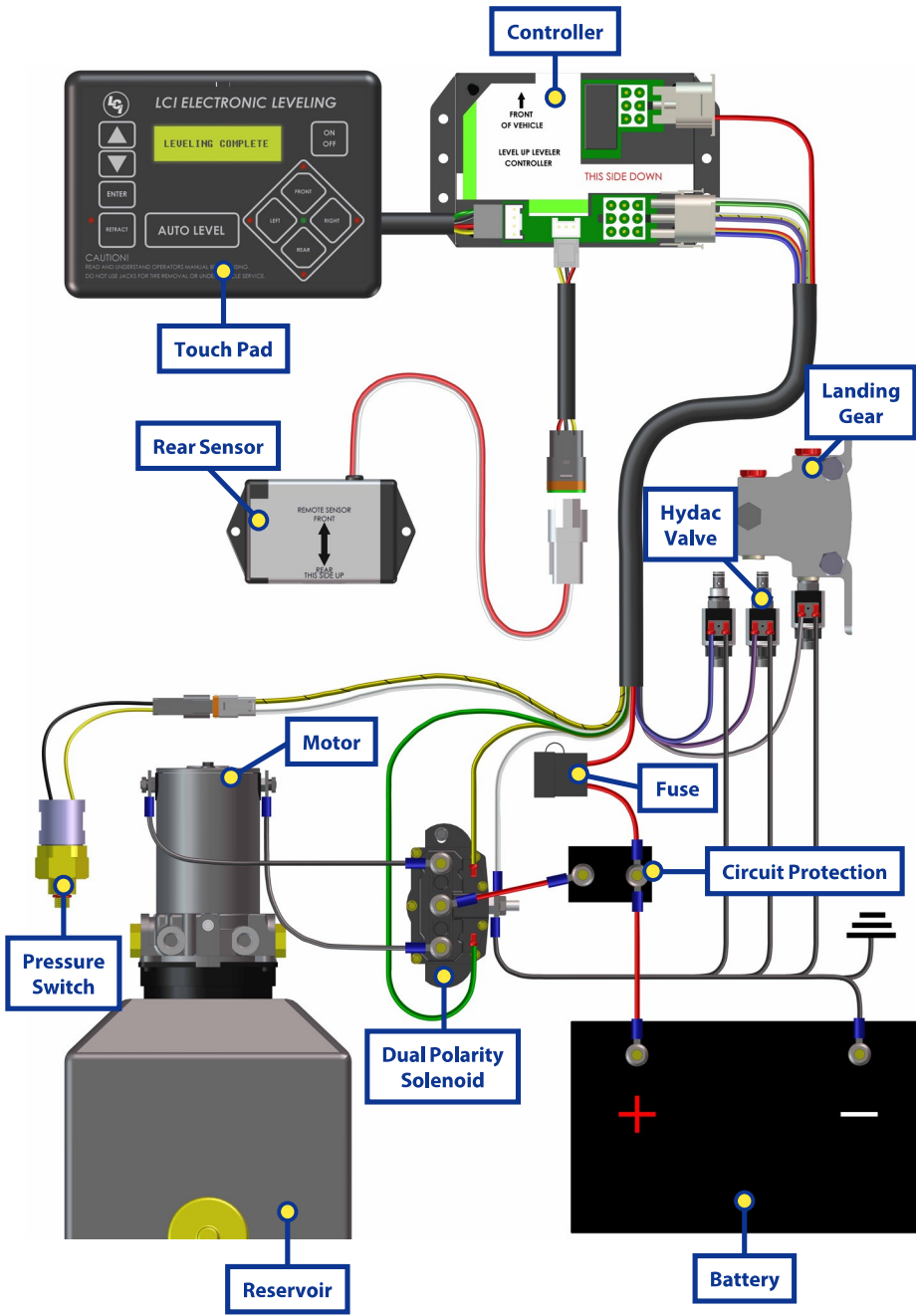

## LEVELING AND STABILIZATION

## System and Safety Information



**Failure to act in accordance with the following may result in death or serious injury.**

The use of the Ground Control® 2.0 to support the unit for any reason other than that which it is intended is prohibited by Lippert's limited warranty. The Ground Control® 2.0 is designed as a "leveling" system only and should not be used to provide service for any reason under the coach such as changing tires or servicing the leveling system. Lippert Components Inc. recommends that a trained professional be employed to change the tire on the unit. Any attempts to change tires or perform other service while unit is supported by the Ground Control® 2.0 could result in death, serious injury or damage to the 5th Wheel.



**Be sure to park the unit on solid, level ground. Clear all jack landing locations of debris and obstructions. Locations should also be free of depressions. When parking the unit on extremely soft surfaces, utilize load distribution pads under each jack. People and pets should be clear of coach while operating leveling system. Never lift the unit completely off the ground. Lifting the unit so the wheels are not touching the ground will create an unstable and unsafe condition.**

## Prior To Operation

The leveling system shall only be operated under the following conditions:

1. Clear all jack landing locations of debris and obstructions. Locations should also be free of depressions.
2. Be sure all persons, pets and property are clear of the coach while Ground Control® 2.0 is in operation.
3. Make sure battery(ies) are fully charged and load test at 12+VDC.
4. Drop inner leg of both landing gear jacks 4-5 inches.

## Operation

Basic Jack

1. Front Landing gear jacks.
2. Rear leveling jacks.

Landing Gear jacks can be operated any time the system is "ON" but NOT in the "AUTO MODE." By pushing the "FRONT" button, both front or landing gear jacks can be extended. By pushing either the "LEFT" or "RIGHT" button, the individual front jacks can be extended. If the touch panel is put in the "RETRACT" mode, indicated by the orange illuminated LED next to the "RETRACT" button, the front jacks can be retracted together by pushing the "FRONT" button or individually by pressing either the "LEFT" or "RIGHT" button.

The rear jacks can only be operated when the touch panel is in the "MANUAL MODE." Once system is in "MANUAL MODE," pressing the "REAR" button will extend both rear jacks at the same time. To operate individual rear jacks, press the "LEFT" or "RIGHT" button first, depending on what is needed at the time, then press the "REAR" button and hold both at the same time.

## Touch Pad Diagram

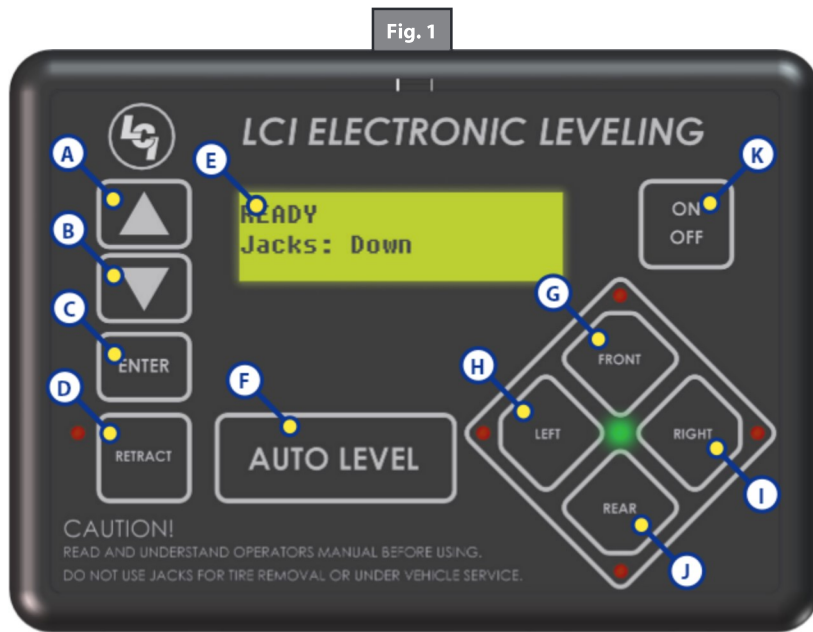

Callout	Description
A	Up Arrow - Scrolls up through the menu on LCD.
B	Down Arrow - Scrolls down through the menu on LCD.
C	Enter - Activates modes and procedures indicated on LCD.
D	Retract - Places leveling system into retract mode - Manual mode ONLY.
E	LCD Display - Displays procedures and results.
F	Auto Level - Places leveling system into auto level mode.
G	Front Button - Activates both front jacks.
H	Left Button - Activates left leveling jack(s) in manual mode.
I	Right Button - Activates right leveling jack(s) in manual mode.
J	Rear Button - Activates leveling jacks in manual mode.
K	Power Button - Turns leveling system on and off.

### Dropping off Unit

1. Loosen J.T. Strong Arm Stabilizer "T" handles. (If applicable.)
2. Disconnect 5th Wheel latch.
3. Turn battery power "ON" (Fig. 3).
4. Release the inner legs of both landing gear jacks by pulling on the quick release pins and extending the inner leg 4-5 inches.
5. Push touch panel "ON/OFF" (Fig. 1K) to turn system on. LCD Screen lights up (Fig. 1E).
6. Push the DOWN ARROW to scroll to "DROP FRONT JACKS" option on LCD screen.

**NOTE:** Orange directional lights (Fig. 4A) may come on, indicating the current disposition of the unit.

7. Push "ENTER" (Fig. 1C). Both front landing gear jacks will go to ground and stop.
8. Push "FRONT" (Fig. 1G) to extend front landing gear jacks manually and lift front of vehicle to clear the 5th wheel hitch plate.
9. Pull tow vehicle away and park at a safe distance.
10. Release the inner legs of both rear leveling jacks by pulling on the quick release pins and extending the inner leg 3-4 inches.
11. Push "AUTO LEVEL." The unit will commence to auto level by setting the landing gear jacks close to level. Rear-most jacks will extend to ground, followed by a second ground verification leveling jacks.
12. When auto level is complete, LCD indicates "Jacks: Down" and the green light in the middle of the jack buttons will light (Fig. 4).
13. Tighten the J.T. Strong Arm stabilizer "T" handles if applicable.

Fig. 2 - Off



Fig. 3 - On



Fig. 4



#### Taking Up Strut Pin Slop (If J.T Strong Arm Stabilizers Are Installed ONLY)

1. After leveling is complete, LCD screen will read "LEVEL SUCCESSFUL/CHECK STABILIZERS."
2. Push "FRONT" (Fig. 1G) momentarily until front stabilizer pins are tight.
3. Push "REAR" (Fig. 1J) momentarily until rear stabilizer pins are tight.
4. Push "ON/OFF" (Fig. 1K) to turn system off.

#### Reconnecting The Unit To A Tow Vehicle

1. Be sure main power switch is "ON."
2. Loosen J.T. Strong Arm Stabilizer "T" handles. (If applicable.)
3. Push "ON/OFF" (Fig. 1K) to turn system on.
4. Push "DOWN ARROW" (Fig. 1B) to scroll to AUTO RETRACT REAR JACKS and push "ENTER" (Fig. 1C). Rear jacks will fully retract and stop.
5. Push "LEFT" and "RIGHT" (Figs. 1H and 1J) together. Front will raise to previous drop off height. Push "FRONT" (Fig. 1G) if more height is needed.
6. Back tow vehicle to align 5th wheel hitch.
7. Push the scroll arrow to display "AUTO RETRACT ALL".
8. Push "ENTER" (Fig. 1C). Landing Gear jacks will automatically retract and then stop.
9. Raise inner drop legs on all jacks (4) and secure with quick release pull pin.
10. Push "ON/OFF" (Fig. 1K) to turn the system off.

#### Truck Hauler Operation (Manual ONLY)

1. Loosen J.T. Strong Arm Stabilizer "T" handles. (If applicable.)
2. Push "ON/OFF" (Fig. 1K). Middle LED lights up green.
3. Push "FRONT" (Fig. 1G) to extend FRONT jacks to gain height.
4. To retract jacks:
  - A. Push "RETRACT" (Fig. 1D); Retract LED lights up orange.
  - B. Push the "FRONT" (Fig. 1G) to retract jacks and hook up vehicle. Once 5th wheel is coupled, push "FRONT" (Fig. 1G) and hold until jacks are fully retracted.
  - C. Let off "FRONT" (Fig. 1G) and push "ON/OFF" (Fig. 1K) to turn system off. Green LED goes dim.
  - D. Double check 5th wheel latch is secure and that all jacks are retracted.
  - E. Ready to tow.

## Calibration

#### Setting The Zero Point

The "Zero Point" is the programmed point that the unit will return to each time the Auto Level feature is used. The "Zero Point" **MUST** be programmed prior to using the Auto Level feature to ensure the proper operation of the system.

**NOTE:** Prior to starting this procedure, double check all connections on the controller, jacks, and touch pad.

1. Manually run the jacks to level the unit. This is best achieved by placing a level in the center of the unit and leveling it both front to back and then side to side. (See "Basic Jack Operation" for instructions on how to manually operate the system).
2. Once the unit is level, turn off the touch pad.
3. With the touch pad off, press and release the "FRONT" button (Fig. 1G) five (5) times and then press and release the "REAR" button (Fig. 1J) five (5) times.
4. The touch pad will flash and beep and the display will read "ZERO POINT CALIBRATION ENTER to set, Power to Exit" (Fig. 5).
5. To set the current position as the zero point, press the "ENTER" button (Fig. 1C).

6. LCD display will read "Zero Point stability check" (Fig. 6).
7. LCD display will read "Zero point set successfully" once process is complete (Fig. 7).
8. The system will set this point as its level state and the touch pad will turn off.

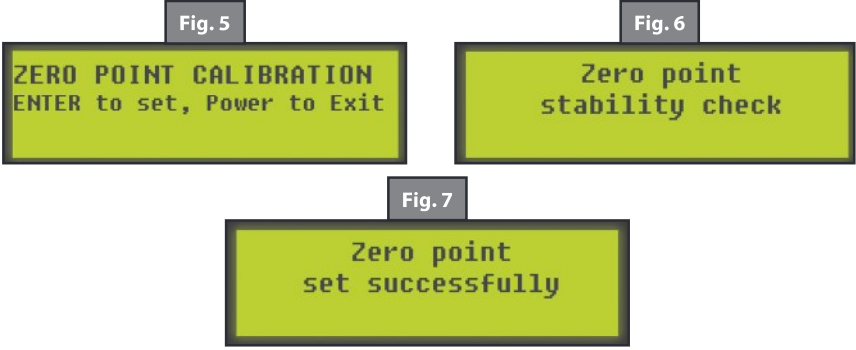

**Preventative Maintenance**

1. Remove dirt and road debris from jacks (and stabilizer struts if equipped) as needed.
2. If jacks are down for extended periods, it is recommended to spray exposed leveling jack tubes with a spray lubricant every 3 months for protection. If your coach is located in a salty environment, it is recommended to spray the rods every month.



**Your coach should be supported at both front and rear axles with jack stands before working underneath. Failure to do so may result in death or serious injury.**

**Troubleshooting**

Special Jack Error Codes

**NOTE:** Only notable when jacks are extended.

To clear one of these errors:

1. Correct or otherwise repair the issue (see the table below).
2. Extend all of the jacks at least six (6) inches, then press and hold the "RETRACT" button on the touch pad until the jacks begin retracting.
3. All of the jacks will retract fully to clear the error.

LCD Message	What's Happening?	What Should Be Done?
***ERROR*** LF Jack RF Jack LM Jack RM Jack LR Jack RR Jack	Error at a specific jack (left front, right front, left rear, right rear). Hall signal issue (open, short, malfunction).  Unexpected high amp current stall.	Check harness connections at controller and at jack. Check harness for damage. Repair or replace as necessary.

## Touch Pad - Error Codes

To clear an error from the touch pad, repair or otherwise correct the issue, then press "ENTER" (Fig. 1C). If the error is still present, the message will be displayed again.

LCD Message	What's Happening?	What Should Be Done?
****ERROR**** Excess Angle	Controller not properly secured.	Check and secure controller placement.
	Excessive angle reached during auto operation.	Relocate the coach.
****ERROR**** Excessive Angle	Controller not properly secured.	Check and secure controller placement.
	Excessive angle reached during manual operation.	Relocate the coach.
****ERROR**** Feature Disabled	Front of coach below level when starting Auto Level process (only when trying to initiate Hitch Recognition).	Raise front of coach above level and restart Auto Level process.
	Touch pad power not cycled between consecutive leveling operations.	Turn touch pad off and then back on to reset the system.
	Zero point not set.	Set zero point.
****ERROR**** Low Voltage	Battery voltage dropped below 10.8V.	Check wiring for loose connection.
		Test battery voltage under load - charge or replace.
****ERROR**** Out Of Stroke	Jack has reached maximum stroke length and is unable to lift.	Check disposition of jacks. Relocate the coach.
****ERROR**** External Sensor	Bad connection or wiring from the controller to the rear sensor.	Replace or repair connection to rear remote sensor.
****ERROR**** Jack Time Out	Time limit exceeded for the requested auto operation.	Check disposition of jacks.
****ERROR**** Auto Level Fail	Unable to auto level due to uneven ground.	Check disposition of jacks. Relocate the coach.
	Unable to auto level due to zero point being set incorrectly.	Reset zero point.
****ERROR**** Comm Error	Communication between controller and touch pad has been lost.	Check harness for proper connections or damage. Replace if necessary.
****ERROR**** Check Stabilizer	Reminder for units equipped with JT Strong Arm to lock the arms.	Lock JT Strong Arm assemblies into place and press FRONT and then REAR to acknowledge.
****ERROR**** Bad Calibration	Sensor calibration values are out of range.	Reset zero point.
****ERROR**** Internal Sensor	Internal sensor problem.	Replace controller.
**PANIC STOP** Function Aborted	The user pressed a button on the touch pad during an automatic operation.	Restart automatic operation and then refrain from pressing any buttons on the touch pad.

## LEVELING AND STABILIZATION

## Safety Information



Failure to act in accordance with the following may result in death or serious injury. The use of the Ground Control® 3.0 leveling system to support the unit for any reason other than which it is intended is prohibited by Lippert's limited warranty. The Lippert leveling system is designed as a "leveling" system only and should not be used to provide service for any reason under the unit such as changing tires or servicing the leveling system. Any attempts to change tires or perform other service while unit is supported by the Ground Control 3.0 leveling system could result in death, serious injury or damage to the 5th wheel.



Be sure to park the unit on solid, level ground. Clear all jack landing locations of debris and obstructions. Locations should also be free of depressions. When parking the unit on extremely soft surfaces, utilize load distribution pads under each jack. People and pets should be clear of coach while operating leveling system. Never lift the unit completely off the ground. Lifting the unit so the wheels are not touching the ground will create an unstable and unsafe condition.

## Prior To Operation

The leveling system shall only be operated under the following conditions:

1. The unit is parked on a reasonably level surface.
2. Be sure all persons, pets and property are clear of the coach while Ground Control® 3.0 is in operation.
3. Make sure battery(ies) are fully charged and load test at 12+VDC.



## Touch Pad Diagram

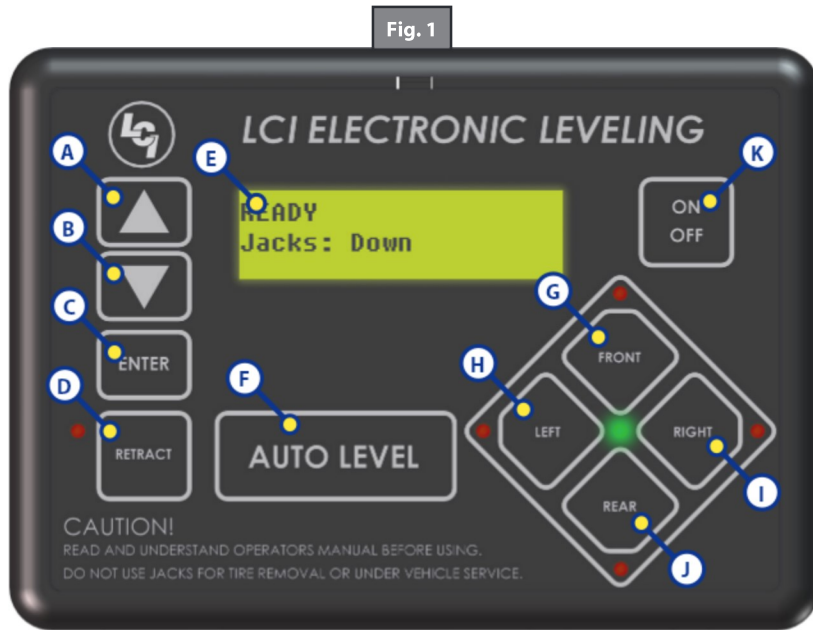

Callout	Description
A	Up Arrow - Scrolls up through the menu on LCD.
B	Down Arrow - Scrolls down through the menu on LCD.
C	Enter - Activates modes and procedures indicated on LCD.
D	Retract - Places leveling system into retract mode - Manual mode ONLY.
E	LCD Display - Displays procedures and results.
F	Auto Level - Places leveling system into auto level mode.
G	Front Button - Activates both front jacks.
H	Left Button - Activates left leveling jack(s) in manual mode.
I	Right Button - Activates right leveling jack(s) in manual mode.
J	Rear Button - Activates leveling jacks in manual mode.
K	Power Button - Turns leveling system on and off.

## Operation

### Basic Jack Operation

Landing gear jacks can be operated any time the system is "ON". By pushing the "FRONT" button (Fig. 1G), both front or landing gear jacks can be extended. By pushing either the "FRONT" and "LEFT" (Fig. 1H) or "FRONT" and "RIGHT" (Fig. 1I) buttons, the individual front jacks can be extended. If the touch pad is put in the retract mode, indicated by the orange illuminated LED next to the "RETRACT" button (Fig. 1D), the front jacks can be retracted together by pushing the "FRONT" button (Fig. 1G) or individually by pressing "LEFT" (Fig. 1H) or "RIGHT" (Fig. 1I) buttons.

**NOTE:** Middle jacks can only be operated in error mode. In order to engage middle jacks, press "LEFT" and "RIGHT" buttons simultaneously.

The rear jacks can only be extended when the touch pad is in the manual mode. Once system is in manual mode, pressing the "REAR" button (Fig. 1J) will extend both rear jacks at the same time. To extend individual rear jacks, press the "LEFT" (Fig. 1H) or "RIGHT" (Fig. 1I) buttons while simultaneously pressing the "REAR" button (Fig. 1J), depending on which jack needs to be operated. If the touch pad is put in the retract mode, indicated by the orange illuminated LED next to the "RETRACT" button (Fig. 1D), the rear jacks can be retracted together by pushing the "REAR" button (Fig. 1J) or individually by pressing either the "LEFT" (Fig. 1H) or "RIGHT" (Fig. 1I) buttons, while simultaneously pressing the "REAR" button (Fig. 1J).

**NOTE:** If the rear jacks will not operate individually using the method described above, but they operate properly when Auto Level is performed, the Twist Prevention Protection system has locked out the operation to prevent damage to the frame of the unit.

### Unhitching From A Tow Vehicle

**NOTE:** Prior to unhitching from the tow vehicle, ensure unit is parked on a level surface and be sure to chock the tires of the unit.

1. Extend the inner legs of both landing gear 4-5 inches by pulling on the quick release pins.
2. Push "ON/OFF" (Fig. 1K). LCD Screen will light up and display "READY JACKS: UP" (Fig. 2).
3. Push the "UP" arrow (Fig. 1A) to scroll to "Drop Front Jacks" option on LCD screen.

**NOTE:** Orange directional lights may come on, indicating the current disposition of the unit.

4. Push "ENTER" (Fig. 1C). Both front landing gear jacks will go to ground and stop.
5. Push the "FRONT" button (Fig. 1G) extending the front landing gear to a sufficient height, which raises the front of the unit off of the tow vehicle's 5th wheel hitch plate.
6. Pull tow vehicle away and park at a safe distance.



### Auto Level

1. After unhitching from tow vehicle and parking the vehicle at a safe distance away from the unit, press the "ON/OFF" button (Fig. 1K) and then press "AUTO LEVEL" (Fig. 1F).

**NOTE:** Once the automatic leveling cycle has been started, it is important that there is no movement in the coach until the unit has completed the leveling process. Failure to remain still during the leveling cycle could have an effect on the performance of the leveling system.

**NOTE:** In order for hitch recognition feature to function, the auto level sequence **MUST** be started with the front of the unit above level.

### Auto Level Sequence

1. When Auto Level Sequence begins, the front of the unit will lower slightly to a point below level. The coach will then stop and raise up to the point where it is level from front to rear.
2. Rear leveling jacks will be grounded.
3. A side to side leveling sequence will occur.

**NOTE:** At this point on the 6-point system, the two middle jacks will be grounded to stabilize the unit. These two jacks do not level the unit.

4. Each jack will perform a final grounding touch.
5. LCD will read "AUTO LEVEL SUCCESS" (Fig. 3).
6. LCD will then read "READY Jacks: Down" (Fig. 4), and the green LED at the center of the four jack buttons will be illuminated (Fig. 4A).

**NOTE:** If the AUTO LEVEL sequence does not perform as described, place the system in manual mode and test that the jacks operate correctly by pushing their coordinating buttons on the touch pad; i.e. FRONT button operates only the front jacks.

Fig. 3



Fig. 4



### Hitch Recognition

1. Turn on the touch pad.
2. Press the left and right buttons simultaneously (Fig. 1H and 1I).
3. All leveling jacks will retract first, then the landing gear will extend to raise the unit to the height where the auto level sequence was started.

**NOTE:** If the auto level sequence was started with the front of the unit in a below-level condition, the Hitch Recognition will not function and the LCD will display "Feature Disabled." In order for the Hitch Recognition feature to function, the auto level sequence **MUST** be started with the front of the unit above level.

### Homing Jacks

4. Introduce an error - disconnect one of the hall effect sensor wires at the controller.
5. Attempt to operate the jack that is associated with the sensor wire that was disconnected. The touch pad screen will display an error for that jack.
6. Reconnect the hall effect sensor wire. Manually extend all jacks down a minimum of 6 inches.
7. Press and hold the retract button until all of the jacks begin to retract. The jacks will retract until they reach the hard current limit.
8. The jacks are now "homed."

**NOTE:** If the jacks do not retract, an error should display on the touch pad screen. This is typically caused by wiring interruption.

**NOTE:** In order to "home" jacks, middle jacks **MUST** also be extended. Refer to Basic Jack Operation for middle jack operation.

## Calibration

### Setting The Zero Point

The "Zero Point" is the programmed point that the unit will return to each time the Auto Level feature is used. The "Zero Point" **MUST** be programmed prior to using the Auto Level feature to ensure the proper operation of the system.

**NOTE:** Prior to starting this procedure, double check all connections on the controller, jacks, and touch pad.

1. Manually run the jacks to level the unit. This is best achieved by placing a level in the center of the unit and leveling it both front to back and then side to side. (See "Basic Jack Operation" for instructions on how to manually operate the system).
2. Once the unit is level, turn off the touch pad.
3. With the touch pad off, press and release the "FRONT" button (Fig. 1G) five (5) times and then press and release the "REAR" button (Fig. 1J) five (5) times.
4. The touch pad will flash and beep and the display will read "ZERO POINT CALIBRATION ENTER to set, Power to Exit" (Fig. 5).
5. To set the current position as the zero point, press the "ENTER" button (Fig. 1C).
6. LCD display will read "Zero point stability check" (Fig. 6).
7. LCD display will read "Zero point set successfully" once process is complete (Fig. 7).
8. The system will set this point as its level state and the touch pad will turn off.

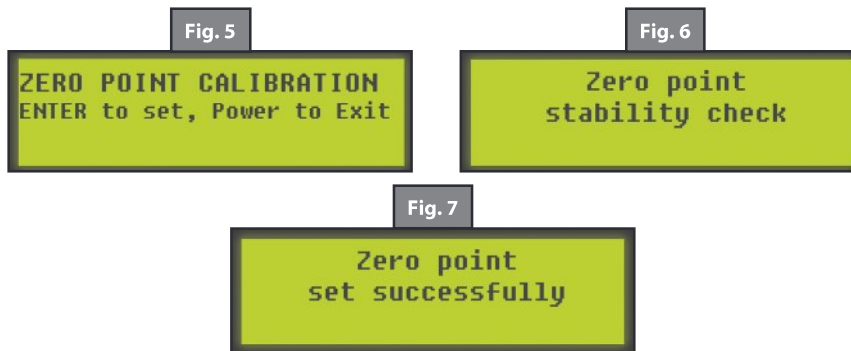

### Preventive Maintenance

1. Remove dirt and road debris from jacks and stabilizer struts (if equipped) as needed.
2. If jacks are down for extended periods, it is recommended to spray exposed leveling jack tubes with a spray lubricant every 3 months for protection. If the coach is located in a salty environment, it is recommended to spray the rods every month.





**Ensure the coach is supported at both the front and rear with jack stands before performing any troubleshooting or service to the unit. Failure to do so may result in death or personal injury.**

## Troubleshooting

### Manual Override - Top of Jack Motor

If manual override is necessary on any jack in the system, there are two options. The following process will describe how to use the top override. See next page for the bottom override.

#### Tools needed:

-  Drill
-  3/8" drive ratchet and extension (no socket)

**NOTE:** Use of a 12V-18V cordless drill or pneumatic drill is acceptable to manually override the jacks. Do not use an impact screw gun to perform the override procedure, as this may damage the motor.

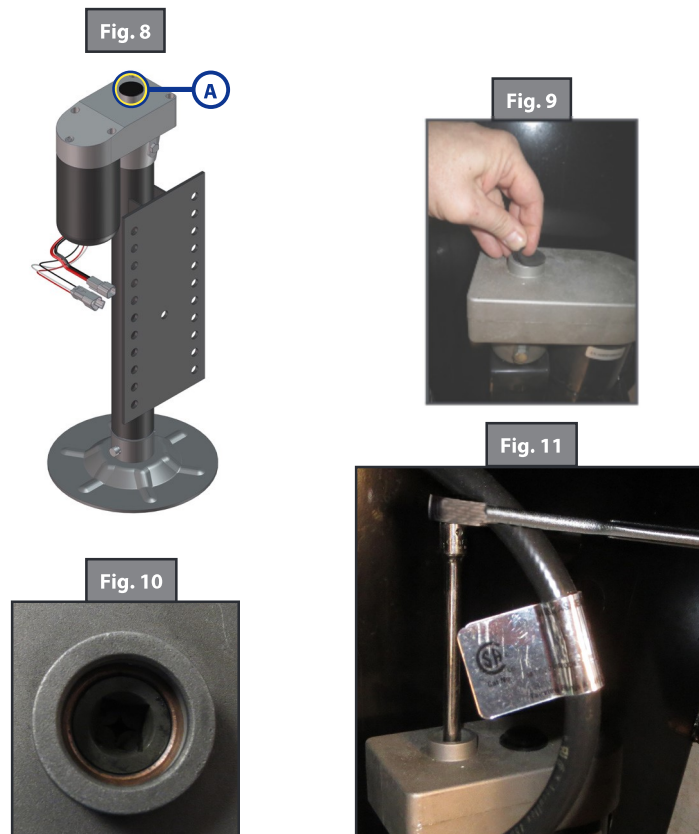

1. Find the port on the top of the jack motor (Fig. 8A).
2. Remove the rubber plug (Fig. 9).
3. Insert the 3/8" drive into the port (Fig. 10).
4. Turn override until the jack extends or retracts to desired position (Fig. 11).



### Manual Override - Bottom of Jack Motor

If manual override is necessary on any jack in the system, there are two options. The following process will describe how to use the bottom override. See previous page for the top override.

#### Tools needed:

-  Drill
-   $\frac{3}{8}$ " drive ratchet and extension,  $\frac{5}{16}$ " socket

**NOTE:** Use of a 12V-18V cordless screw gun or pneumatic screw gun is acceptable to manually override the jacks. Do not use an impact screw gun to perform the override procedure, as this may damage the motor.

1. Find the port on the bottom of the jack motor (Fig. 12A).
2. Remove the rubber plug (Fig. 13).
3. Insert the  $\frac{5}{16}$ " socket into the port (Fig. 14).
4. Turn override until the jack extends or retracts to desired position (Fig. 15).

Fig. 12

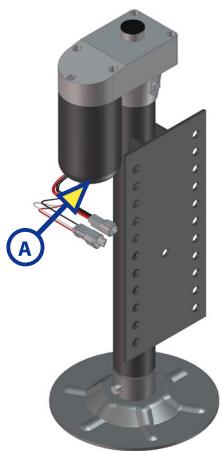

Fig. 13



Fig. 14

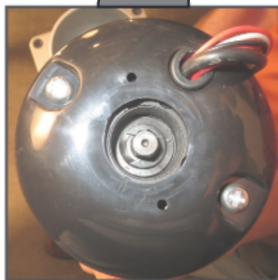

Fig. 15



## Touch Pad - Error Codes

To clear an error from the touch pad, repair or otherwise correct the issue, then press "ENTER" (Fig. 1C). If the error is still present, the message will be displayed again.

LCD Message	What's Happening?	What Should Be Done?
****ERROR**** Excess Angle	Controller not properly secured.	Check and secure controller placement.
	Excessive angle reached during auto operation.	Relocate the coach.
****ERROR**** Excessive Angle	Controller not properly secured.	Check and secure controller placement.
	Excessive angle reached during manual operation.	Relocate the coach.
****ERROR**** Feature Disabled	Front of coach below level when starting Auto Level process (only when trying to initiate Hitch Recognition).	Raise front of coach above level and restart Auto Level process.
	Touch pad power not cycled between consecutive leveling operations.	Turn touch pad off and then back on to reset the system.
	Zero point not set.	Set zero point.
****ERROR**** Low Voltage	Battery voltage dropped below 10.8V.	Check wiring for loose connection.
		Test battery voltage under load - charge or replace.
****ERROR**** Out Of Stroke	Jack has reached maximum stroke length and is unable to lift.	Check disposition of jacks. Relocate the coach.
****ERROR**** External Sensor	Bad connection or wiring from the controller to the rear sensor.	Replace or repair connection to rear remote sensor.
****ERROR**** Jack Time Out	Time limit exceeded for the requested auto operation.	Check disposition of jacks.
****ERROR**** Auto Level Fail	Unable to auto level due to uneven ground.	Check disposition of jacks. Relocate the coach.
	Unable to auto level due to zero point being set incorrectly.	Reset zero point.
****ERROR**** Comm Error	Communication between controller and touch pad has been lost.	Check harness for proper connections or damage. Replace if necessary.
****ERROR**** Check Stabilizer	Reminder for units equipped with JT Strong Arm to lock the arms.	Lock JT Strong Arm assemblies into place and press FRONT and then REAR to acknowledge.
****ERROR**** Bad Calibration	Sensor calibration values are out of range.	Reset zero point.
****ERROR**** Internal Sensor	Internal sensor problem.	Replace controller.
**PANIC STOP** Function Aborted	The user pressed a button on the touch pad during an automatic operation.	Restart automatic operation and then refrain from pressing any buttons on the touch pad.



### Special Jack Error Codes

**NOTE:** Only notable when jacks are extended.

To clear one of these errors:

1. Correct or otherwise repair the issue (see the table below).
2. Extend all of the jacks at least six (6) inches, then press and hold the "RETRACT" button on the touch pad until the jacks begin retracting.
3. All of the jacks will retract fully to clear the error.

LCD Message	What's Happening?	What Should Be Done?
***ERROR*** LF Jack RF Jack LM Jack RM Jack LR Jack RR Jack	Error at a specific jack (left front, right front, left rear, right rear). Hall signal issue (open, short, malfunction).	Check harness connections at controller and at jack. Check harness for damage. Repair or replace as necessary.
	Unexpected high amp current stall.	

## LEVELING AND STABILIZATION







## Safety Information



**Failure to act in accordance with the following may result in death or serious injury.**

The use of the Hydraulic Landing Gear to support the coach for any reason other than which it is intended is prohibited by Lippert's limited warranty. The Hydraulic Landing Gear system is designed as a system to drop the unit off of a truck, level the unit from front to back and stabilize the front of the unit only and should not be used to provide service for any reason under the coach such as changing tires or servicing the landing gear.

Lippert Components, Inc. recommends that a trained professional be employed to change the tire of the coach. Any attempts to change tires or perform other service while coach is supported by the hydraulic landing gear could result in death, serious personal injury and/or damage to the coach.

-  Be sure to park the coach on solid, level ground.
-  Clear all jack landing locations of debris and obstructions. Location should also be free of depressions.
-  When parking the coach on extremely soft surfaces, utilize load distribution pads under each jack.
-  People and pets should be clear of coach while operating hydraulic landing gear system.
-  Be sure to keep hands and other body parts clear of fluid leaks. Oil leaks in the hydraulic landing gear may be under high pressure and can cause serious skin penetrating issues.
-  Never lift the coach completely off the ground. Lifting the coach so the wheels are not touching ground will create an unstable and unsafe condition.

### System Information

Please read and study the operating manual before you operate the Hydraulic Landing Gear. The Hydraulic Landing Gear is an electric/hydraulic system. A 12V DC electric motor drives a hydraulic pump that moves fluid through a system of hoses, fittings and jacks to level and stabilize the coach. There are no serviceable parts within the electric motor. If the motor fails, it **MUST** be replaced. Disassembly of the motor voids the warranty.

Mechanical portions of the Hydraulic Landing Gear are replaceable. Contact Lippert Components, Inc. to obtain replacement parts.

### Component Information

Hydraulic Landing Gear is powered from a central 12VDC motor/pump assembly, which also includes the hydraulic oil reservoir tank, control valve manifold, and solenoid valves. The Hydraulic Landing Gear is controlled electronically from the switch near the pump.

### Prior To Operation

The Hydraulic Landing Gear shall only be operated under the following conditions:

1. The unit is parked on a reasonably level surface.
2. The towing vehicle is disengaged from the unit.
3. Be sure all persons, pets and property are clear of the coach while Hydraulic Landing Gear is in operation.

## Operation

**NOTE:** If the landing gear is connected to a leveling system, please refer to that system's section for operation.

1. Locate landing gear switch panel
2. Press "EXTEND" to extend the landing gear.
3. Press "RETRACT" to retract the landing gear.

## Maintenance

The Hydraulic Landing Gear has been designed to require very little maintenance. To ensure the long life of your slide-out system, read and follow these few simple procedures.

1. Check the fluid level every month.
  - A. Check fluid only when jacks are fully retracted.
  - B. Always fill the reservoir with the jacks in the fully retracted position. Filling reservoir when jacks are extended will cause reservoir to overflow into its compartment when jacks are retracted.
  - C. When checking fluid level, fluid should be within ¼" of fill spout lip.
2. Inspect and clean all Pump Unit electrical connections every 12 months.
3. Remove dirt and road debris from Landing Gear as needed.



**The coach should be supported at both front and rear axles with jack stands before working underneath. Failure to do so may result in death or serious injury.**

The Hydraulic Landing Gear has been static tested to over 6,000 continuous cycles without any noticeable wear to rotating or sliding parts. It is recommended that when operating in harsh environments and conditions (road salt, ice build-up, etc.) the moving parts be kept clean. They can be washed with mild soap and water. No grease or lubrication is necessary and in some situations may be detrimental to the environment and long-term dependability of the system.

### Mechanical Components

Although the system is designed to be almost maintenance-free, actuate the landing gear once or twice a week to keep the seals and internal moving parts lubricated.

Check for any visible signs of "leaking" before and after movement of the system and the coach. When the landing gear is down, visually inspect the inner and outer assemblies. Refer to components list for location of inner assemblies. Check for excess build-up of dirt or other foreign material; remove any debris that may be present.

If the system squeaks or makes any noises it is permissible to apply a coat of lightweight oil or silicone lubricant spray to the hydraulic rod but remove any excess oil so dirt and debris do not build-up. DO NOT use grease.

### Electrical Components

For optimum performance, the landing gear system requires full battery current and voltage. The battery **MUST** be maintained at full capacity. Other than good battery maintenance, check the terminals and other connections at the battery, the control switch and the pump motor for corrosion and loose or damaged terminals. Check motor leads under the coach chassis. Since these connections may be subject to damage from road debris, be sure they are in good condition.

**NOTE:** The Hydraulic Landing Gear is designed to operate as a negative ground system. A negative ground system utilizes the chassis frame as the ground source. An independent ground wire back to the battery is not needed. It is important the electrical components have good wire to chassis contact. Over 90% of unit electrical problems can be attributed to bad ground connections.

**NOTE:** For long-term storage: It is recommended that the room be closed (retracted) and if your unit is equipped with the IRC room control, it is recommended all of the control knobs be kept in the closed position.

### Fluid Recommendation

The Lippert Electronic Leveling System is pre-filled, primed and ready to operate direct from the manufacturer. Type "A" Automatic Transmission Fluid (ATF) is utilized and will work. ATF with Dexron III® or Mercon 5® or a blend of both is recommended by Lippert Components, Inc.

In colder temperatures (less than 10° F) the jacks may extend and retract slowly due to the fluid's molecular nature. For cold weather operation, fluid specially formulated for low temperatures may be desirable. For a list of approved fluid specifications, see TI-188.

1. Remove Breather/Fill Cap (Fig. 1).
2. Pour ATF into Breather/Fill opening.

**NOTE:** Do not allow any contamination into reservoir during fill process.

**NOTE:** Standard reservoir holds approximately 2 quarts (1.89 liters) of ATF.

3. Fill to within ½" of top.
4. Replace Breather/Fill cap when finished.

**NOTE:** System is self-purging. By simply cycling the system 2-3 times, any air in the system will be forced back to the reservoir and out of the Breather/Fill cap.

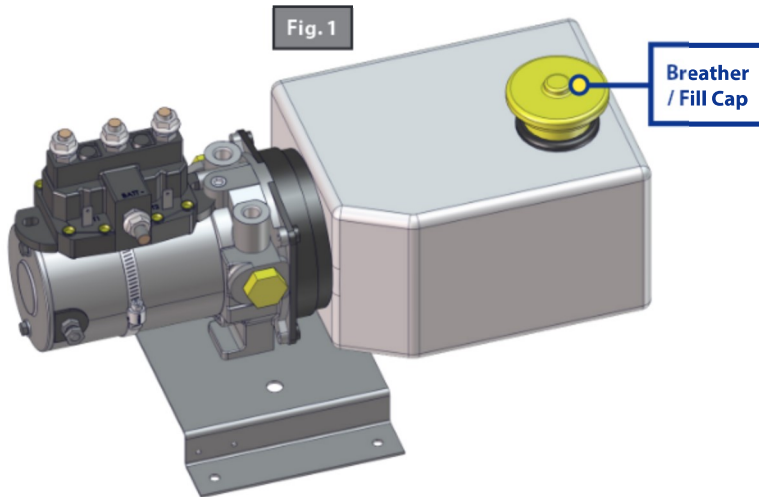

## Troubleshooting

### Power Unit

Before attempting to troubleshoot the power unit, make sure an adequate power source is available. The unit batteries should be fully charged or the unit should be plugged into to A/C service with batteries installed. Do not attempt to troubleshoot the power unit without assuring a full 12V DC charge.

The following tests require only a DC voltmeter (or DC test light) and a jumper lead.

1. Attach voltmeter (or test light) leads to the negative and positive terminals on motor solenoid. Does the meter indicate 12V DC? If YES, see Step 2; if NO see Step 3.
2. If YES, at the motor, check the incoming leads to 12V DC (if necessary, disconnect leads at wire splices). Does meter indicate 12V DC? If YES, power unit needs to be replaced. The motor is not field serviceable. Do not attempt to repair. If NO, inspect all wires and connections between the wall switch and the motor. Repair connections as necessary. Recheck as in Step 1.
3. If NO, inspect all connections between battery and solenoid. Inspect 30A Auto-reset Circuit Breaker. Recheck as above in Step 1.

**NOTE:** Since there are no field serviceable parts in the motor of the power unit, electrical troubleshooting and service is limited to replacing only those components as previously outlined.

**NOTE:** Thorough inspection of wiring and connections is the only other electrical service that can be performed.

What Is Happening?	Why?	What Should Be Done?
Jacks will not extend to ground, pump is running.	Little or no fluid in reservoir.	Fill reservoir with Dexron III ATF.
	Leg valve is inoperative.	Clean, repair or replace.
	Electronic signal is lost between switch and leg valves.	Trace wires for voltage drop or loss of signal. Repair or replace necessary wires or replace switch.
Any one or two jacks will not retract.	Hose damaged or not connected.	Replace with new hose or reconnect.
	Return valve is inoperative.	Replace inoperative return valve.
	Electronic signal is lost between switch and solenoid.	Attempt to retract jacks in manual mode, if successful replace control pad; if not, test voltage drop.
	Electronic signal is lost between switch and leg valve.	Repair bad wiring or replace defective board or valve.

### Manual Override

The Hydraulic Landing Gear can be manually operated with an electric drill. In the event of electrical or system failure, this manual method of extending and retracting the landing gear can be used.

**NOTE:** Unhook the power unit motor from the power source prior to attempting the manual override procedure.

1. Locate the valve(s) located on the landing gear to be manually overridden (Fig. 1).
2. Using a  $\frac{5}{32}$ " hex wrench, open the valve by turning the manual override set screw clockwise (Fig. 2A).
3. Remove protective label (Fig. 3A) from power unit to reveal the manual override coupler.
4. Using an electric drill with a  $\frac{1}{4}$ " hex bit, insert the hex bit into the manual override coupler to manually operate the Hydraulic Landing Gear (Fig. 4).
  - A. Run the drill forward (clockwise) to retract the landing gear (Fig. 4A).
  - B. Run the drill in reverse (counterclockwise) to extend the landing gear (Fig. 4B).
5. Be sure to turn the manual override set screw on the valve (Fig. 5A) back to the counterclockwise position after extending or retracting the landing gear.

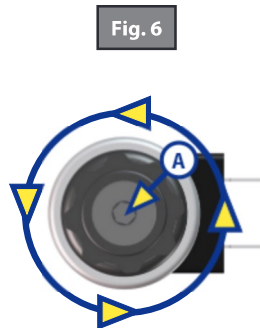
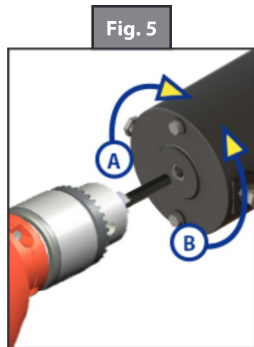
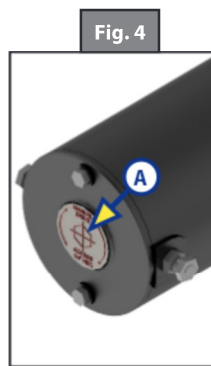
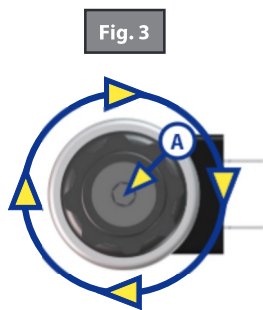
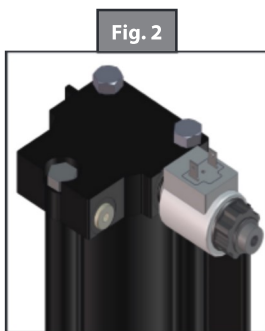

## LEVELING AND STABILIZATION

## Safety Information







**Failure to act in accordance with the following may result in death, serious injury and/or damage to the coach.**

**Any attempts to change tires or perform other service while coach is supported solely by the Electric Stabilizer Jack could result in death, serious injury, unit or system damage. The coach should be supported at both front and rear axles with jack stands before working underneath.**

**Failure to act in accordance with the following may result in death or serious injury. Always make sure that the Electric Stabilizer Jack area is clear of people and objects before and during operation of the stabilizer jack. Always keep away from the stabilizer jack when it is being operated. There are areas that may pinch or catch on loose clothing causing death, serious injury and/or damage to the coach.**



The Electric Stabilizer Jack is intended for the purpose of stabilizing either or both ends of the unit. The use of this system for any reason other than which it is intended is prohibited by Lippert's Limited Warranty and may result in death, personal injury, unit or system damage.

**NOTES:**

-  Be sure to park the unit on solid, level ground.
-  Clear all stabilizer jack landing locations of debris and obstructions. Locations should also be free of depressions.
-  When parking the unit on extremely soft surfaces, utilize load distribution pads under each jack.
-  People and pets should be clear of coach while operating Electric Stabilizer Jack.
-  Never lift the coach completely off the ground. Lifting the coach so the wheels are not touching the ground will create an unstable and unsafe condition.

**System Information**

Please read and study the operating manual before operating the Electric Stabilizer Jack. The Electric Stabilizer Jack is a 12VDC electric motor-driven system. The electric motor drives an acme threaded screw to extend and retract the stabilizer legs to stabilize the unit's rear end. The Electric Stabilizer Jack is designed to operate as a negative ground system.

-  There are no serviceable parts within the electric motor. If the motor fails, it **MUST** be replaced.
-  Disassembly of the motor voids the warranty.
-  Mechanical portions of the Electric Stabilizer Jack are replaceable. Contact Lippert Components, Inc. to obtain replacement parts.

## Operation

### Extending Stabilizer Jack

1. Level the unit.
2. Verify the battery is fully charged and hooked-up to the electrical system.
3. Press and hold EXTEND (Fig. 1A) until the stabilizer jack foot pads contact the ground and the unit is stabilized.
4. Release the switch.

### Retracting Stabilizer Jack

1. Verify the battery is fully charged and hooked-up to the electrical system.
2. Press and hold RETRACT (Fig. 1B) until the stabilizer jack is fully retracted.
3. Release the switch.

Fig. 1

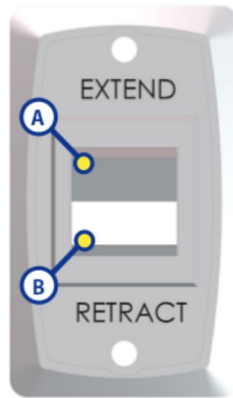

## Maintenance

### Mechanical Maintenance

It is recommended that when operating in harsh environments (road salt, ice build up, etc.) the moving parts be kept clean. They can be washed with mild soap and water. No grease or lubrication is necessary and in some situations may be detrimental to the environment and long term dependability of the system.



**Do not work on the stabilizer jack unless the battery is disconnected. Failure to act in accordance with the following may result in death or serious injury.**

### Electrical Maintenance

For optimum performance, the system requires full battery current and voltage. The battery **MUST** be maintained at full capacity. Other than good battery maintenance, check the terminals and other connections at the battery, the control switch, and the electric motor for corrosion, and loose or damaged terminals. Check motor leads under the trailer chassis. Since these connections are subject to damage from road debris, be sure they are in good condition.

**NOTE:** The Electric Stabilizer Jack is designed to operate as a negative ground system. A negative ground system utilizes the chassis frame as a ground and an independent ground wire back to battery is necessary. It is important that the electrical components have good wire to chassis contact. Over 90% of unit electrical problems are due to bad ground connections.



## Troubleshooting

### Manual Override



**Always disconnect battery from system prior to manually operating system. Any damage due to misuse of the Manual Override feature or failure to disconnect battery can cause electricity to back feed through the motor and cause serious damage to the system as well as void the Limited Warranty.**

The Electric Stabilizer Jack comes with a manual override system located on the end opposite of the electric motor in the form of a crank handle (Fig. 3) that fits over a coupler and pin (Fig. 2A).

To manually operate the stabilizer jack:

1. Disconnect one of the wire leads from the motor to prevent backfeeding the motor.
2. Next, insert the ½" dia. crank handle over the coupler and pin. The slot in the end of the crank handle (Fig. 3A) accommodates the pin on the coupler (Fig. 2A) to allow the manual extension/retraction of the stabilizer jack.
3. Rotate the crank handle clockwise to retract or counterclockwise to extend the stabilizer jack.

**NOTE:** The gears can be stripped out if the stabilizer jack is manually retracted/extended to its fullest extent and the operator continues to rotate manual override.

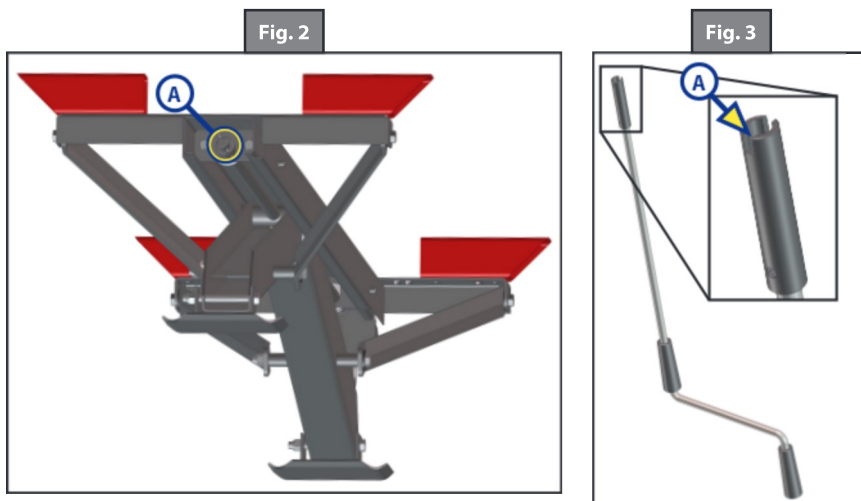

## LEVELING AND STABILIZATION

## Safety Information













The "WARNING" symbol above is a sign that a service or maintenance procedure has a safety risk involved and may cause death or serious injury if not performed safely and within the parameters set forth in this manual.

Always wear eye protection when performing service or maintenance to the vehicle. Other safety equipment to consider would be hearing protection, gloves and possibly a full face shield, depending on the nature of the service.

This manual provides general service and maintenance procedures. Many variables can change the circumstances of the service procedure, i.e., the degree of difficulty involved in the service operation and the ability level of the individual performing the operation. This manual cannot begin to plot out procedures for every possibility, but will provide the general instructions for effectively servicing the vehicle. In the event the skill level required or the procedure too difficult, a certified technician should be consulted before performing the necessary service. The owner's manual for the unit may have more procedures for service and maintenance.



**Failure to correctly service the vehicle may result in death, serious injury or property damage.**

-  **NEVER allow anyone unfamiliar with this product to install, operate or service this product.**
-  **NEVER lift or level this the trailer without a properly installed footpad.**
-  **NEVER crank jack or couple trailer without preventing the trailer from rolling.**
-  **NEVER exert excessive side forces to the jack unit.**
-  **NEVER allow anyone, including operator to put any body parts under the jack or the supported load during jack operation.**
-  **NEVER drop the trailer off the hitch ball.**
-  **NEVER exceed load capacity.**
-  **NEVER use jack to lift trailer for service or tire change.**
-  **NEVER move trailer before jack is fully retracted.**
-  **NEVER use jack unless footpad retaining pin is fully inserted through both sides of the jack's inner tube.**

## Operation

### Extending The Tongue Jack

1. Chock trailer tires.
2. Be sure footpad is pinned securely in place with clevis & hair pins (Fig. 2A).
3. Push ON to turn the Power Tongue Jack on (Fig. 1A).
4. Make sure ground surface under jack is firm and level.
5. Push EXT side of switch to EXTEND jack until coupler clears hitch ball (Fig. 1D).
6. Move tow vehicle away from trailer.
7. Push OFF to turn the Power Tongue Jack off to conserve battery power (Fig. 1B).

**NOTE:** If left on for extended periods of time, the courtesy light will drain the battery.

### Retracting The Tongue Jack

1. Chock trailer tires.
2. Push ON to turn the Power Tongue Jack on (Fig.1A).
3. Push RET side of switch to RETRACT jack until coupler properly mounts hitch ball (Fig. 1C).
4. Push OFF to turn the Power Tongue Jack off to conserve battery power (Fig. 1B).

**NOTE:** If left on for extended periods of time, the courtesy light will drain the battery.

**NOTE:** Be sure inner tube of jack is fully retracted prior to moving vehicle (Fig. 2B).

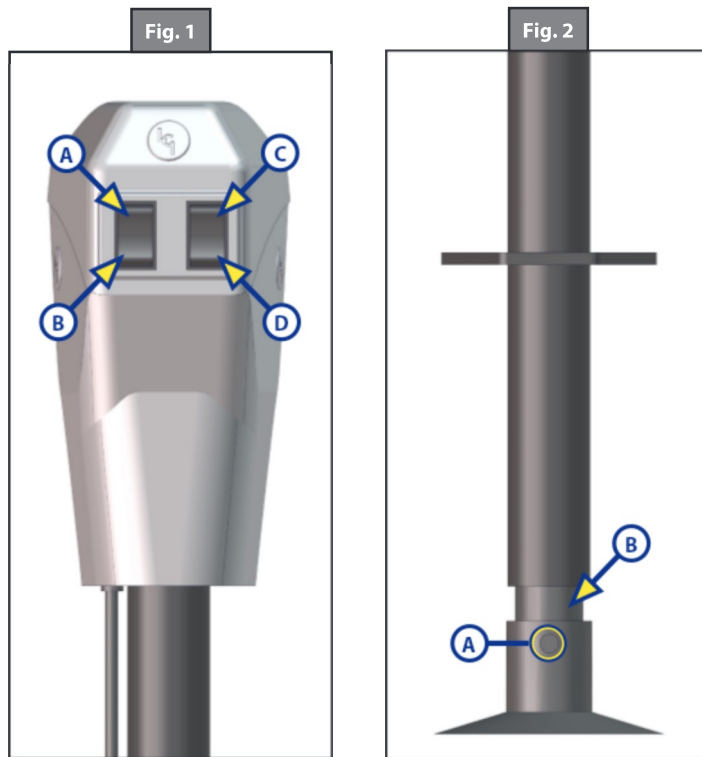

## Troubleshooting

### Manual Operation

If 12VDC power is unavailable to operate the Power Tongue Jack, use the following directions to manually operate the jack.

To Extend:

1. Chock trailer tires.
2. Be sure footpad is pinned securely in place with clevis and hair pins (Fig. 4A).
3. Make sure ground surface under jack is firm and level.
4. Open rubber plug on top of jack's gearbox to expose manual drive shaft (Fig. 5A).
5. Insert manual crank handle (Fig. 6).
6. Turn handle clockwise until trailer is supported and coupler clears hitch ball.
7. Move tow vehicle away from trailer.
8. Lower trailer until it is level by turning crank handle counterclockwise.
9. Remove crank handle (Fig. 6).
10. Replace rubber plug (Fig. 5A).

To Retract:

1. Chock trailer tires.
2. Be sure footpad is pinned securely in place with clevis and hair pins (Fig. 4A).
3. Open rubber plug on top of jack's gearbox to expose manual drive shaft (Fig. 5A).
4. Insert manual crank handle (Fig. 6).
5. Turn crank handle counterclockwise until coupler properly mounts hitch ball.
6. Remove crank handle (Fig. 6).
7. Replace rubber plug (Fig. 5A).

**NOTE:** Be sure inner tube of jack is fully retracted prior to moving vehicle (Fig. 4B).

Fig. 3

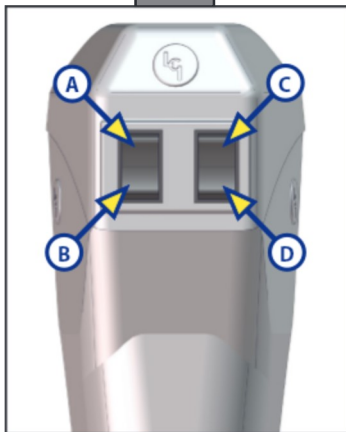

Fig. 4

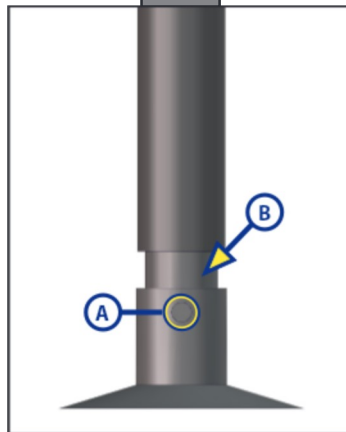

Fig. 5

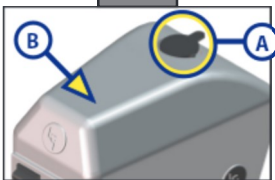
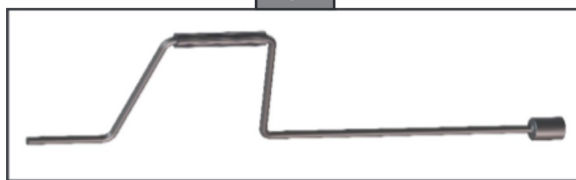

Fig. 6



### Power Tongue Jack Clutch

The Power Tongue Jack is provided with a motor, clutch and a 30A fuse. Fuse is located underneath the lid (Fig. 5B) of the jack and will need to be replaced if it blows. It **MUST** be replaced with a 30A ATO-type fuse. Battery **MUST** be fully charged, free of defects, and full of water prior to operating the jack. Low voltage from the battery will cause the fuse to blow prematurely.

The clutch will slip under two conditions:

1. The jack may have reached its extend or retract limit.
2. That the tongue weight of the trailer has exceeded the capacity limits of the jack. Items stored in the trailer can vastly influence the weight distribution of the jack. Reorganize stored items if Power Tongue Jack motor clutch continues to slip.

**NOTE:** Release switch immediately when clutch noise occurs. The clutch is the overload protection for the motor. The clutch should not slip during normal operation. This will cause excessive wear on the clutch and the motor.

**NOTE:** If left on for extended periods of time, the courtesy light will drain the battery.

**NOTE:** The Power Tongue jack is designed for jacking the trailer in a vertical disposition only.

## Safety Information



The “WARNING” symbol above is a sign that a service or maintenance procedure has a safety risk involved and may cause serious injury or death if not performed safely and within the parameters set forth in this manual. Always wear eye protection when performing service or maintenance to the vehicle. Other safety equipment to consider would be hearing protection, gloves and possibly a full face shield, depending on the nature of the service.

This manual provides general service and maintenance procedures. Many variables can change the circumstances of the service procedure, i.e., the degree of difficulty involved in the service operation and the ability level of the individual performing the operation. This manual cannot begin to plot out procedures for every possibility, but will provide the general instructions for effectively servicing the vehicle. In the event the skill level required or the procedure is difficult, a certified technician should be consulted before performing the necessary service. Failure to correctly service the vehicle may result in voiding the warranty, inflicting injury or even death. The owner's manual for your unit may have more procedures for service and maintenance.

### Electric Drum Brakes

The break-in period is a typical phenomenon with drum brakes and especially electric drum brakes. Electric drum brakes will require a break-in period to achieve full performance. This break-in period applies for new axles and any time new brake shoes and/or magnets are installed as part of regular maintenance.

Lippert Components has found through extensive brake testing that the break-in period for our drum brakes can range from 20 to 50 brake applications.

Brakes can be seated in by applying approximately 8-10 volts to the trailer brakes at an initial speed of 40 mph and allowing the truck/trailer combination to slow down to 20 or 25 mph. For best results do not use truck brakes during this procedure. The trailer brakes will seat in faster by using them to stop both the truck and trailer. The easiest method is to apply the trailer brakes using the manual activation lever located on the in-cab brake controller. Care **MUST** be taken to not overheat the lining material, therefore brake applications conducted at one mile intervals will suffice. The driver should feel a noticeable difference in the brake performance during this period, sometimes in as few as 10 applications. After 50 applications, the brake lining material will be fully cured from the heat and develop close to 100% contact with the brake drum surface.

This break in period not only seats the shoe lining material but also seats in the brake electromagnets. During the break-in period, the linings will wear at a faster rate than they do after they are seated in.

**NOTE:** Brakes should be manually adjusted after the first 200 miles of operation and periodically thereafter, approx. 3,000 mile intervals.

## Hubs/Drums/Bearings

### Hub Removal

To remove the hub assembly for inspection, maintenance or service, follow the six (6) steps below:



**Lift unit by the frame and never the axle or suspension. Do not go under unit unless it is properly supported by jack stands. Unsupported units can fall causing death or serious injury.**

1. Lift trailer and support it per manufacturer's requirements.
2. Remove the wheel.
3. Remove the grease cap by prying the edge out of the hub. If equipped with oil lubrication, unscrew oil cap using a 2 ½" socket. Let oil drain into pan.
4. Pull the cotter pin from the castle nut and remove the outer spindle nut.
5. Remove the spindle washer.
6. Pull the hub off the spindle. Do not let the outer bearing cone fall free of the assembly. The inner bearing cone will be contained by the seal and will not fall out.

**NOTE:** Brakes may need to be adjusted or backed off to remove drum from spindle.

**NOTE:** A gear puller may be necessary to remove hub from spindle.

### Brake Drum Inspection

The brake shoes contact the drum surface and the magnet contacts the armature.

These surfaces are subject to wear and should be inspected periodically.

The drum surface should be re-machined if wear is more than .030" or out of round by more than .015". The drum should be replaced if scoring or wear is greater than .090".

The inner surface of the brake drum that contacts the brake magnet is the armature surface. If the armature surface is scored or worn unevenly, it should not be machined more than .030". The magnets should be replaced whenever the armature surface is refaced and vice versa.

**NOTE:** Ensure that the wheel bearing cavities are clean and free of contamination before reinstalling bearing and seals. Resurfacing procedures can produce metal chips and dust that can contaminate the wheel bearings and cause failure.

Bearing Inspection

Wash all grease and oil from the bearing cone using a suitable solvent. Dry the bearing with a clean, lint-free cloth and inspect each roller completely. If any pitting, spalling, or corrosion is present, then the bearing **MUST** be replaced. The bearing cup inside the hub **MUST** be inspected.

**NOTE:** Bearings **MUST** always be replaced in sets of one cone and one cup.



**Always wear eye protection when servicing the axle, brakes, hubs, springs and wheels. Failure to wear eye protection may result in serious injury.**

Drum	Maximum Re-bore Diameter
7"	7.09"
10"	10.09"
12"	12.09"

Follow the procedure below to replace the bearing cup:

1. Place hub on a flat surface with bearing cup on the bottom.
2. With brass drift punch, lightly tap around the small end of the cup to push it out.
3. Clean the hub bore. Replace the cup by tapping it back in with the brass drift punch. Cup should be seated against the retaining shoulder in the hub.

Consult Bearing Replacement Chart for proper replacement bearings.

**NOTE:** Replacing the bearing cup is a very precise process. The cup **MUST** be perfectly seated when replaced. If the cup is not seated correctly, damage to the assembly may not be covered by the warranty. Consult Lippert Components, Inc. prior to replacing bearing and bearing cup. The trailer should be taken to a certified service center for this work to be done.

**Do not mix Lithium, calcium, sodium or barium complex greases. Chemical compatibility problems may occur. If you are changing from one chemical grease to**



**another, be sure all old grease is removed prior to applying new grease. If the old grease is not removed completely, chemical compatability may result in component failure or damage.**



### Bearing Lubrication - Oil

If your axles are equipped with oil lubricated hubs, then your lubrication procedure is to periodically fill the hub with a high quality hypoid gear oil to the level indicated on the clear plastic oil cap. The oil can be filled through the rubber plug hole in the cap.

### Bearing Lubrication - Grease

Bearing grease should be replaced every 12,000 miles or 12 months, whichever comes first. Remove all old grease from wheel hub and bearings first. Bearings should be packed by machine if possible. Packing bearings by machine is preferable; however, packing by hand is a viable alternative.

Follow these procedures to repack bearings by hand:

1. Place grease into the palm of your hand (Fig. 1).
2. Press widest end of bearing into the outer edge of the grease pile, forcing grease into the inner area of the bearing between two adjacent rollers (Fig. 2).
3. Repeat this process while turning bearing from roller to roller until all rollers are coated.
4. Apply a light coat of grease into the bearing cup surface.
5. Reassemble bearing into cup.

Fig. 1



Fig. 2



Recommended Wheel Bearing Grease Specifications	
Thickener Type	Lithium Complex
Dropping Point	230°C (446°F) Minimum
Consistency	NLGI No. 2
Additives	EP, Corrosion, & Oxidation Inhibitors
Base Oil	Solvent Refined Petroleum Oil
Base Oil Viscosity	@40°C (104°F) 150cSt (695 SUS) Minimum
Viscosity Index	80 Minimum
Pour Point	-10°C (14°F) Minimum

Approved Sources	
Mobil Oil	Mobilgrease HP
Exxon/Standard	Ronex MP
Kendal Refining Co.	Kendall L-427
Ashland Oil Co.	Valvoline Val-plex EP Grease
Pennzoil Prod. Co.	Premium Wheel Bearing Grease 707L

### Seal Inspection and Replacement

Always check the seal to make sure that it is not damaged, nicked, cracked or torn and is in good working order. If there is any question of condition, replace the seal.

Procedure to replace seal:

1. Pull seal from the hub with a seal puller. Never push the seal out with the bearing. The bearing may get damaged.
2. Apply a PERMATEX sealant to the outside of the new seal.

**NOTE:** Do not use PERMATEX on rubber encased seals.

3. Tap the new seal into place using a clean, hardwood block (Fig. 3).

**NOTE:** When installing a new oil seal, be sure side marked "AIR SIDE" is away from bearing cone.

Fig. 3



Fig. 4



### Bearing Adjustment/Hub Replacement

To adjust bearings or replace removed hub, follow procedures below:

1. Place hub, bearing, washers and castle nut back on axle spindle in the reverse order from which they were removed. Castle nut should be torqued to 50 ft.-lb. Hub will rotate during this process.
2. Loosen castle nut to back off the torque.
3. Tighten castle nut finger tight until snug.
4. Insert cotter pin. If cotter pin does not line up with hole, back castle nut up slightly until pin can be inserted (Fig. 4).
5. Bend cotter pin over to lock nut in place. Nut should be free to move with only the cotter pin keeping it in place.

## Electric Brakes

The basic structure of the Electric Brakes on your trailer will resemble the brakes on your car or tow vehicle, with one major difference; your trailer implements an Electric Actuation system and your tow vehicle utilizes a hydraulic system. The Electric Braking System operates in the following order of steps: (Refer to the Electric Braking System Diagram and the brake diagram below to follow along.)

1. Electric current is supplied to the trailer's braking system when the tow vehicle's brakes are applied.
2. From the tow vehicle's battery, the electricity flows to the brake's electromagnet.
3. When energized the magnets are attracted to the rotating surface of the drums.
4. This moves the actuating levers in the direction the drums are turning.
5. The actuating cam at the end of the shoe forces the primary shoe out to the drum surface.
6. The force of the primary shoe actuates the secondary shoe to contact the drum.
7. The force applied to the brake drum can be increased by elevating the current flow to the magnet.

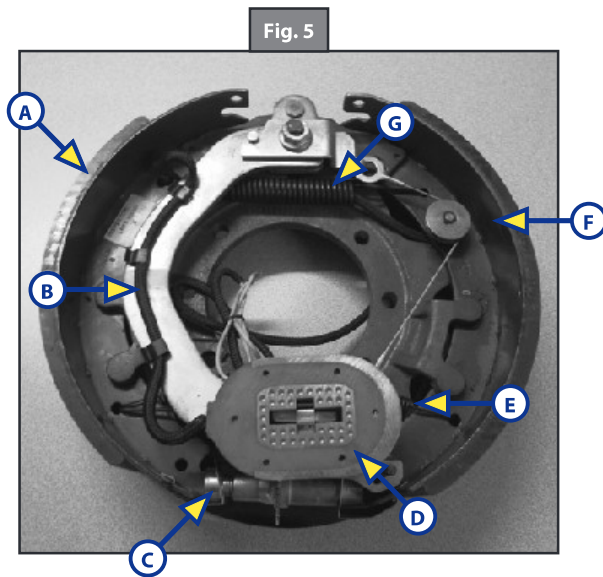

Callout	Description
A	Primary Shoe
B	Actuating Lever
C	Adjuster
D	Magnet
E	Adjusting Spring
F	Secondary Shoe
G	Retracting Spring

### How To Use Electric Brakes Properly

The Electric Braking System is synchronized with the tow vehicle brakes. Never attempt to stop the combined load of the tow vehicle and the trailer by using either the tow vehicle brakes or the trailer brakes only. They are designed to work together. Small manual adjustments may occasionally be necessary to accommodate changing loads and driving conditions. Synchronization of tow vehicle to trailer braking can only be accomplished by road testing. Locking up, excessive grab, or delayed application is quite often due to the lack of synchronization between the tow vehicle and the trailer being towed. High voltage (2V+), Low voltage (2V-) or improperly adjusted brakes are the most common causes of these problems and can be easily remedied. Prior to any adjustments, your trailer brakes should be burnished-in by applying the brakes 20-30 times with a 20 m.p.h. decrease in speed, e.g. 40 m.p.h. to 20 m.p.h. Allow ample time for brakes to cool between application. This allows the brake shoes and magnets to begin seating to the brake drum.

Trailer Wire Gauge Chart		
Wire Gauge and Type	Number of Axles	Length of Run
16 Ga Stranded Copper	1	N/A
14 Ga Stranded Copper	2	Under 30ft. (9.1m) from hitch to center of axles
12 Ga Stranded Copper	2 or 3	Over 30ft. (9.1m) from hitch to center of axles

### Maintenance - Electric Brakes

#### Brake Adjustment



**Prior to testing or adjusting brakes, be sure area is clear of any persons and vehicles. Failure to perform test in a clear area may result in death or serious injury.**

Electric Brakes are automatic adjust only. If manual adjusting is needed, the following 6-step procedure can be utilized. The brakes should be adjusted in the following manner:

1. Jack up trailer and secure on adequate capacity jack stands. Follow trailer manufacturer's recommendations for lifting and supporting the unit. Make sure the wheel and drum rotates freely.
2. Remove the adjusting hole cover from the adjusting slot on the bottom of the brake backing plate.
3. With a screwdriver or standard adjusting tool, rotate the starwheel of the adjuster assembly to expand the brake shoes. Adjust the brake shoes out until the pressure of the linings against the drum makes the wheel very difficult to turn.
4. Then rotate the starwheel in the opposite direction until the wheel turns freely with a slight lining drag.

**NOTE:** A second screwdriver will be needed to push the auto adjusting lever away from the adjuster starwheel so that the starwheel can be rotated backwards.

5. Replace the adjusting hole cover and lower the wheel to the ground.
6. Repeat the above procedure on all brakes. For best results, the brakes should all be set at the same clearance.

### Lubricate Brakes

Prior to reassembling the brake drum assembly, remember to apply a light film of white grease or an anti-seize compound on the brake anchor pin, the actuating arm bushing and pin, and the areas on the backing plate that are in contact with the brake shoes and magnet lever arm. In addition apply a light film of grease on the actuating block mounted on the actuating arm.

### Clean and Inspect Brakes

In the event the braking system encounters symptoms of improper application or failure, immediate inspection and service **MUST** be implemented. During normal use, servicing the braking system once a year is considered normal. Increased usage will require service on a regulated schedule based on 3000-6000 mile increments. As magnets and shoes become worn, they need to be changed to maintain maximum braking capability.

Be sure, when disassembling brakes for cleaning, to clean the backing plate, magnet arm, magnet and shoes. Also, make sure that any and all parts removed for cleaning are placed back into the same brake drum assembly. This is also an excellent time to check for parts that have become loose or worn.



#### Potential Asbestos Dust Hazard.

Older brake linings have the potential to contain asbestos dust, which has been linked to serious or fatal illnesses. Certain precautions **MUST** be taken when servicing brakes:

1. Avoid creating and/or breathing any brake dust.
2. Do not machine, file, or grind the brake linings.
3. Remove with a damp brush or cloth. Dry brushing or compressed air will cause the dust particles to become airborne.

### Magnets

This electric braking system utilizes an electromagnet to actuate the brake shoes. These high-quality magnets provide superior force and friction to safely and effectively stop the trailer. These magnets should be inspected and serviced on the same schedule as the rest of the axle system, at least once a year for normal use and more often if the trailer is used extensively. Abnormal or uneven wear is a sign that the magnet needs to be replaced. Check the surface of the magnet with a straight edge to check for uneven wear. The surface of the magnet should be completely flat.

If the magnet's coil is exposed in any way, even if normal wear is evident, the magnets should be replaced immediately. If the electromagnets are replaced, the drum armature surface should also be refaced. If a magnet is replaced on one side of an axle, it is recommended that the magnet on the opposite brake assembly also be replaced to ensure even braking capacity. Figure 6 shows an Electro-Magnet with little or no wear. If there are any pronounced gaps on the surface of the Electro-Magnet, the magnet should be replaced.

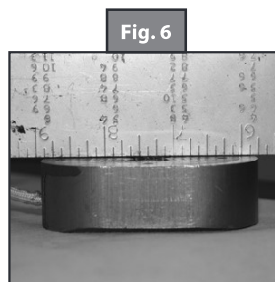

Fig. 6

### Shoes and Linings

Linings should be replaced if the material is worn to  $\frac{1}{16}$ " or less. Shoes should also be replaced if they become contaminated with grease or oil or have become scored, pitted or gouged. Heat cracks are normal and rarely require attention. When replacing shoes, both shoes on the same brake and the brakes on the same axle should all be replaced at the same time, once again ensuring even braking capacity.

After replacing shoes and linings, your trailer brakes should be burnished-in by applying the brakes 20-30 times with a 20 m.p.h. decrease in speed, e.g. 40 m.p.h. to 20 m.p.h. Allow ample time for brakes to cool between application. This allows the brake shoes and magnets to begin seating to the brake drum.

### **Axle and Suspension Installation**

The single most important portion of axle installation is parallel alignment of the trailer axle(s) to the tow vehicle or drive axle(s). Parallel installation allows for correct and safe control, prolonged tread life and will all but eliminate dog-tracking. Proper alignment is most readily achieved by measuring from the center of the trailer king pin to the center of each end of the axles.

Lippert Components, Inc. tubular axles are made of high strength steel to prevent metal fatigue and provide the best possible welding conditions. The round tubular axles allow for even and uniform structure.



**Always wear eye protection when servicing the axle, brakes, hubs, springs and wheels.  
Failure to wear eye protection may result in serious injury.**

### Suspension Systems

The suspension systems incorporated into Lippert Component, Inc. axles are designed to provide the following benefits:

1. Attach the axle to the trailer.
2. Dampen the effects of road shock.
3. Provide stability to the trailer.

All Lippert suspension systems are available in single and multiple axle configurations. For specific or custom applications, please contact Lippert Components, Inc. Axle Division.

### Double-Eye Leaf Springs

Double-eye leaf springs have eyes at either end of the spring assembly with nylon bushings to assist in preventing wear. U-bolts hold the springs to the axle with a plate. The articulation of this suspension occurs when the eyes rotate on the wear surfaces provided in eyes of the springs and on the equalizers. This suspension is also available in single and multiple axle configurations.

In trailers with 2 or more axles, the additional movement is maintained by an equalizer. This feature allows for even load handling from axle to axle. Double-eye suspension systems are available on 8,000 lb. axles. Tandem and triple axle mounting kits are available for both 33" and 35" axle spacing.

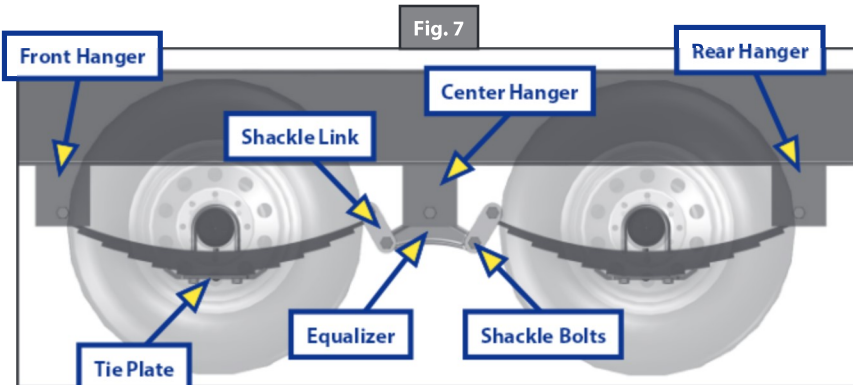

Spring Axle Torque Specifications		
Bolt Type	Axle Capacity	Maximum Torque
U-Bolts	2K	25 ft-lb
	3.5K with ½"	50 ft-lb
	5.2K	65 ft-lb
	6-8K	90 ft-lb
	Minimum Torque	Maximum Torque
Shackle Bolts	30 ft-lb	50 ft-lb

### Torsion Suspension System

1. The Lippert Components, Inc. Torsion Suspension system is designed to offer superior qualities over leaf spring technology. The Lippert Components, Inc. Torsion Suspension system is bracketed to the trailer's frame and housed inside the trailer axle's tube.
2. The spindle is connected to a swing arm, the swing arm is connected to a square inner bar that is sheathed in rubber and as the swing arm rotates and experiences the torque and resistance of driving conditions, the characteristics of the rubber absorb and distribute the load providing benefit over leaf spring suspensions.
3. The Lippert Components, Inc. Torsion Suspension system requires very little attention in regards to maintenance. Normal inspection of the entire Lippert Components, Inc. Trailer Axle system can be applied to the Torsion Suspension system. See inspection procedures for system components in this manual.

**NOTE:** For Torsion installation, mount axle bracket to frame bracket (Fig. 8) and torque fasteners as specified in the chart below.

**NOTE:** Washer(s) **MUST** be placed against the slotted hole in the axle bracket (Fig. 8A).

**NOTE:** Low profile brackets have plain round holes.

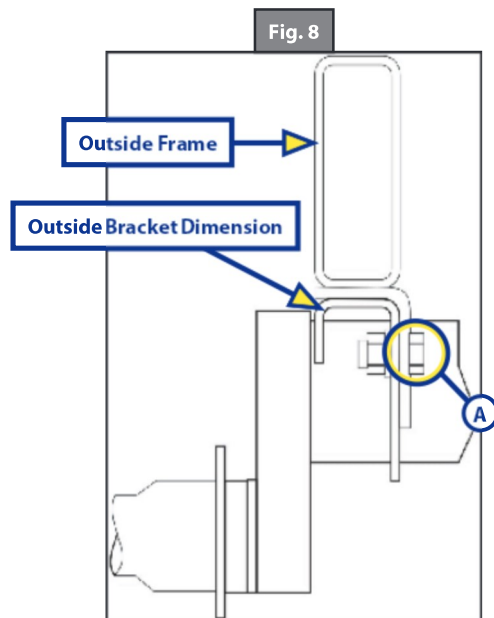

Torsion Axle Torque Specifications		
Axle Size	Bolt Size	Torque Range
#8 - #9	1/2"	70-90 ft-lb
#10 - #13	5/8"	120-150 ft-lb



## Inspection

All the components of your suspension system should be visually inspected for signs of wear, damage or loose fasteners at least every 6,000 miles. When replacing or tightening loose fasteners, consult the torque specs on page 13 for correct torque values.

Worn spring eye bushings or sagging or broken springs should be replaced using the following method:

1. Support the trailer with the wheels just off the ground. Follow the trailer manufacturer's recommendations for lifting and supporting the unit.
2. After the unit is properly supported place a suitable block under the axle tube near the end to be repaired. This block is to support the weight of the axle only so that suspension components can be serviced or replaced.
3. Disassemble the U-bolts, nuts, and tie plates.
4. Remove the spring eye bolts and the spring.
5. If the spring eye bushings are to be replaced, press out the old bushing by hand or tapping out with a punch.
6. Free-floating nylon bushing needs no lubrication. Press the new bushing into the spring eye by hand or gently tapping it in with a bounce less rubber or plastic mallet.
7. Reinstall repaired or replaced components in reverse order.

**NOTE:** For multiple axle units, the weight of each axle **MUST** be supported as outlined in Step 2 before disassembly of any component of the suspension system.

**Lift unit by the frame and never the axle or suspension. Do not go under unit unless**



**it is properly supported by jack stands. Unsupported units can fall causing death or serious injury.**

**Always wear eye protection when servicing the axle, brakes, hubs, springs and wheels.**



**Failure to wear eye protection may result in serious injury.**

If the equalizer or equalizer bushings **MUST** be replaced, follow the instructions above for lifting and supporting the trailer unit and then proceed as follows:

1. With both axles blocked up, remove the spring eyebolt, keeper bolt, and equalizer bolt from the equalizer to be repaired or replaced.
2. Press the old nylon bushing out of the equalizer.
3. Reassemble in reverse order.

## Suspension Replacement

1. Make sure springs are on straight. Align spring eyes to front hanger. Insert spring eye bolts but do not torque at this point.
2. Assemble springs into equalizer.
3. After leveling equalizer to frame, torque equalizer nuts and spring eye nuts to a minimum of 30 ft.-lb. and a maximum of 50 ft.-lb.

## Wheels

### Wheel Selection

When specifying or replacing your trailer wheels it is important that the wheels, tires, and axle are properly matched. The following characteristics are extremely important and should be thoroughly checked when replacement wheels are considered:

1. Bolt Circle. Wheels have many bolt circle variations and some are so close that it could be possible to attach an inappropriate wheel that does not match the axle hub.
2. Capacity. Wheel load capacity should match tire and trailer max. load ratings.
3. Offset. The relationship of the center line of the tire to the hub face of the axle should match any replacement. Failure to match offset may result in reducing the carrying capacity of your axle.
4. Rim Contour. Replacement wheels should be direct replacements to match the rim contour.



**Use only rim contours suggested by manufacturer. Failure to use correct rim contour may cause dramatic separation of tire and wheel and could cause death or serious injury.**

**Attempting to modify or repair a wheel can cause unsafe conditions that may result in an explosion. Air pressure on a weakened or cracked rim can cause death or serious injury.**

## Torque Requirements

It is extremely important to apply and maintain proper wheel mounting torque on your trailer axle. Torque wrenches assure the proper amount of torque is being applied to a fastener. Use no other method to torque fasteners.



**Proper and accurate torque MUST be maintained to prevent wheels from loosening, studs from cracking and/or breaking or other possible hazardous breakage resulting in death or serious injury.**

Be sure to use only the fasteners matched to the cone angle of your wheel (usually 60° or 90°). The proper procedure for attaching your wheels is as follows:

1. Start all bolts or nuts by hand to prevent cross threading.
2. Tighten bolts or nuts in the following sequence (see Wheel Torque Requirement Chart below).
3. Tightening fasteners should be done in stages. Follow the recommended sequence (Fig. 9), tighten fasteners per wheel torque requirements chart below.
4. Wheel nuts/bolts should be torqued before first road use and after each wheel removal. Check and re-torque after the 10 and 25 miles and again at 50 miles. A periodic check during regular service is recommended.

Wheel Torque Requirement Chart				
Wheel Size	Stud Size	Torque Sequence		
		1st Stage	2nd Stage	3rd Stage
14"	½"	20-25 ft-lbs	50-60 ft-lbs	90-120 ft-lbs
15"	½"	20-25 ft-lbs	50-60 ft-lbs	90-120 ft-lbs
16"	½"	20-25 ft-lbs	50-60 ft-lbs	90-120 ft-lbs
16.5" x 6.75"	½"	20-25 ft-lbs	50-60 ft-lbs	90-120 ft-lbs
16"	⅝"	20-25 ft-lbs	60-70 ft-lbs	120-130 ft-lbs
16.5" x 6.75"	⅝"	20-25 ft-lbs	60-70 ft-lbs	120-130 ft-lbs
16" Dual and 17.5" Cone Nut	⅝"	50-60 ft-lbs	100-120 ft-lbs	190-210 ft-lbs
16" Dual and 17.5" Flange Nut	⅝"	50-60 ft-lbs	150-200 ft-lbs	275-325 ft-lbs
14.5" Demount	⅝"	Tighten sequentially to 85-95 ft-lbs		

Fig. 9

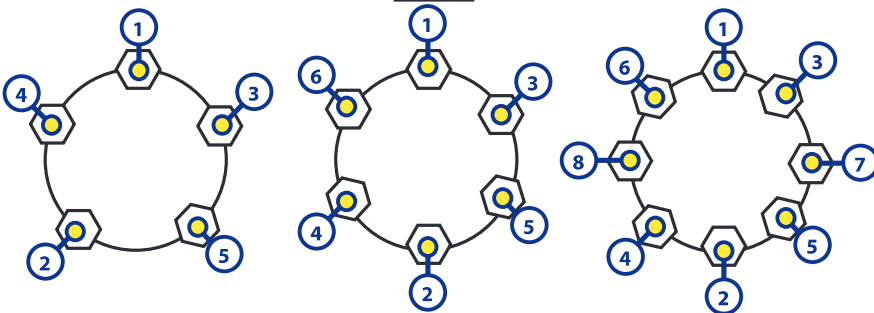

## Tires







Prior to mounting tires onto wheels, be sure the rim size and contour are approved by the Tire and Rim Association Yearbook or the tire manufacturers catalog. In addition, confirm that the tire will carry the rated load. If the load is not evenly distributed on all tires, use the tire rated for the heaviest wheel position.

The Rubber Manufacturers Association or the tire manufacturers guidelines should be consulted for mounting procedures.

Tire inflation pressure is the most important factor in tire life. Tire pressure should always be what is recommended by the manufacturer for the load. Always check pressure cold before operation. DO NOT bleed air from tires when they are hot. Check inflation pressure weekly during use to insure maximum tire and tread life.

The following tire wear diagnostic chart will help you pinpoint the causes and solutions of tire wear problems.

**NOTE:** Tire wear should be checked frequently because once a wear pattern becomes firmly established in a tire it is difficult to stop, even if the underlying cause is corrected.

What Is Happening?	Why?	What Should Be Done?
Center Wear 	Over-inflation	Adjust pressure to particular load per tire catalog.
Edge Wear 	Under-inflation	Adjust pressure to particular load per tire catalog.
Side Wear 	Loss of camber or overloading	Make sure load does not exceed axle rating. Call Lippert Service & Warranty to advise.
Toe Wear 	Incorrect Toe-in	Call Lippert Service & Warranty to advise.
Cupping 	Out-of-balance	Check bearing adjustment and balance tires.
Flat Spots 	Wheel lockup and tire skidding	Avoid sudden stop if possible and adjust brakes.

## Introduction To Troubleshooting

The following section is a guideline for ensuring operation of your braking system. The safety of you, those traveling with you and those sharing the road paramount and it starts with the ability to safely stop the tow vehicle and the towed vehicle.

### Troubleshooting

Most brake malfunctions can be corrected by utilizing the Troubleshooting Chart on the next page. Mechanical failure is the most common form of malfunction, however, if the brake system fails and it's not mechanical, it is usually electrical. A Voltmeter and Ammeter are essential tools to diagnose these problems.

Mechanical problems are mostly self-evident; something is bent or broken. Consult the troubleshooting chart on Page 19 to determine the probable cause and corrective actions for a variety of issues with the braking system.

Remember to use only Lippert Components, Inc. replacement parts on these systems. Consult the Limited Warranty or call our Service Department for any other related issues.

### Measuring Voltage

The Braking System voltage is measured at the two lead wires of the magnet on any brake. Use the pin probes inserted through the insulation of the lead wires. To ensure that the battery is indicating a full charge, the towing vehicle engine should be running with the trailer coupler connected when checking the voltage.

Voltage in the system should begin at 0 volts and, as the brake pedal of the tow vehicle is applied, voltage will gradually increase to about 12 volts. If the system does not indicate at least 12 volts, problems may occur in the wiring of the system, the battery or alternator of the tow vehicle.

When the brakes are applied, a gradual increase in voltage is preferable to a quick increase to 12 volts. A gradual increase in voltage ensures smooth and firm trailer braking. A quick increase in voltage will cause the braking system to feel like the trailer is grabbing too quickly.

Taking a Voltage reading is usually done with probes inserted into the wire connector (Fig. 10).

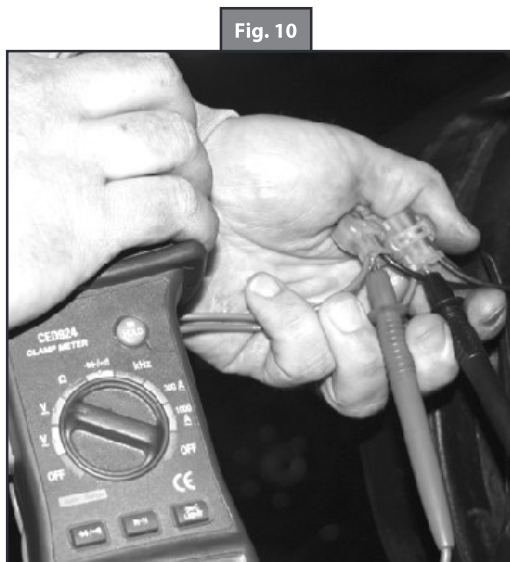

## Troubleshooting Chart

What Is Happening?	Why?	What Should Be Done?
No brakes	Open circuits	Find and correct
	Short circuits	Test and correct
	Severe under-adjustment	Adjust brakes
Weak brakes	Grease or oil on magnets or linings	Clean or replace
	Corroded connections	Clean and correct cause of corrosion
	Worn linings or magnets	Replace
	Scored or grooved brake drums	Machine or replace
	Improper synchronization	Correct
	Under-adjustment	Adjust brakes
	Glazed Linings	Re-burnish or replace
Locking brakes	Under-adjustment	Adjust
	Improper synchronization	Correct
	Loose, bent or broken brake components	Test and correct
	Out-of-round brake drums	Machine or replace
	Insufficient wheel load	Adjust system resistor and synchronize
Intermittent brakes	Broken wires	Test and correct
	Loose connections	Repair or replace
	Faulty ground	Find and repair
Brakes pull to one side	Wrong magnet lead wire color	Adjust
	Incorrect adjustment	Correct
	Grease or oil on linings or magnets	Clean or replace
	Broken wires	Find and repair
	Bad connections	Find and repair
Harsh brakes	Under-adjustment	Adjust
	Improper synchronization	Correct
Noisy brakes	Under-adjustment	Adjust
	Lack of lubrication	Lubricate
	Broken	Replace component
	Incorrect brake components	Correct
Surging brakes	Grease or oil on linings or magnets	Clean or replace
	Out-of-round or cracked brake drums	Machine or replace

What Is Happening?	Why?	What Should Be Done?
Dragging brakes	Over-adjustment	Readjust
	Out-of-round brake drums	Machine or replace
	Incorrect brake components	Replace
	Loose, bent or broken brake components	Replace
	Faulty breakaway switch	Repair or replace
	Loose wheel bearing adjustment	Adjust
	Bent spindle	Replace Axle

**NOTE:** If all trailer lights and brakes do not work, check your wiring plug connection and make sure the ball is making solid contact with the coupler (that is how a trailer is grounded). Too much grease or not using dielectric grease on the ball and coupler can cause this to happen.

#### Measuring Amperage

The Braking System amperage is the amount of current flowing through the system when all magnets have been energized. The amperage will change proportionately with the voltage. To ensure that the battery is indicating a full charge, the towing vehicle engine should be running with the trailer coupler connected when checking the voltage.

If a resistor is used in the brake system, it **MUST** be set at zero or bypassed completely to obtain the maximum amperage reading. Individual amperage draw can be measured by inserting the ammeter in the line at the magnet you want to check. Disconnect one of the magnet lead wire connectors and attach the ammeter between the two wires. Consult Amperage Chart on the next page for normal amp readings. Make sure that the wires are properly reconnected and sealed after testing is completed.

Testing for Amperage can be done with probes (Fig. 11) or alligator clips on the leads or an amp clamp (Fig. 12).

Fig. 11



Fig. 12



Amperage Chart

Amps/Magnet	Two Brakes	Four Brakes	Six Brakes
3.0	6.0	12.0	18.0

Low or no voltage are the most common problem with the Braking System. Amperage at the brakes is also a relatively common issue. Common causes of these conditions are:

1. Low quality electrical connections
2. Open circuits
3. Insufficient wire gauge
4. Broken wires
5. Blown fuses (fusing of brakes is not recommended)
6. Short circuits (indicated by high amperage)

Possible causes of shorts are:

1. Shorted magnet coils
2. Bare wires contacting a grounded object

Finding the cause of a short circuit in the system is done by isolating one section at a time. If the high amperage reading drops to zero by unplugging the trailer, then the short is in the trailer. If the amperage reading remains high with all the brake magnets disconnected, the short is in the trailer wiring.

All electrical troubleshooting procedures should start at the controller. Most complaints regarding brake harshness or malfunction are traceable to improperly adjusted or nonfunctional controllers. See your controller manufacturer's data for proper adjustment and testing procedures. For best results, all the connection points in the brake wiring should be sealed to prevent corrosion. Loose or corroded connectors will cause an increase in resistance which reduces the voltage available for the brake magnets.



## Maintenance Schedule

Item	Function Required	Weekly	3 Months / 3,000 Miles	6 Months / 6,000 Miles	12 Months / 12,000 Miles
Brakes	Test that they're operational.	At Every Use			
Breakaway System	Check battery charge and switch operation.	At Every Use			
Brake Adjustment	Adjust to proper operating clearance.		◆		
Brake Magnets	Inspect for wear and current draw.			◆	
Brake Linings	Inspect for wear or contamination.				◆
Brake Controller	Check for correct amperage and modulation.			◆	
Trailer Brake Wiring	Inspect wiring for bare spots, fray, etc.				◆
Hub/Drum	Inspect for abnormal wear or scoring.				◆
Wheel Bearing	Inspect for corrosion or wear. Clean and repack.				◆
Seals	Inspect for leakage. Replace if removed.				◆
Springs	Inspect for wear, loss of arch.				◆
Suspension Parts	Inspect for bending, loose fasteners, wear.			◆	
Hangers	Inspect welds.				◆
Wheel Nuts and Bolts	Tighten to specified torque values.		◆		
Wheels	Inspect for cracks, dents, or distortion.			◆	
Tire Inflation Pressure	Inflated tires to mfg's specifications.	◆			
Tire Condition	Inspect for cuts, wear, bulging, etc.		◆		

### Wiring Diagram

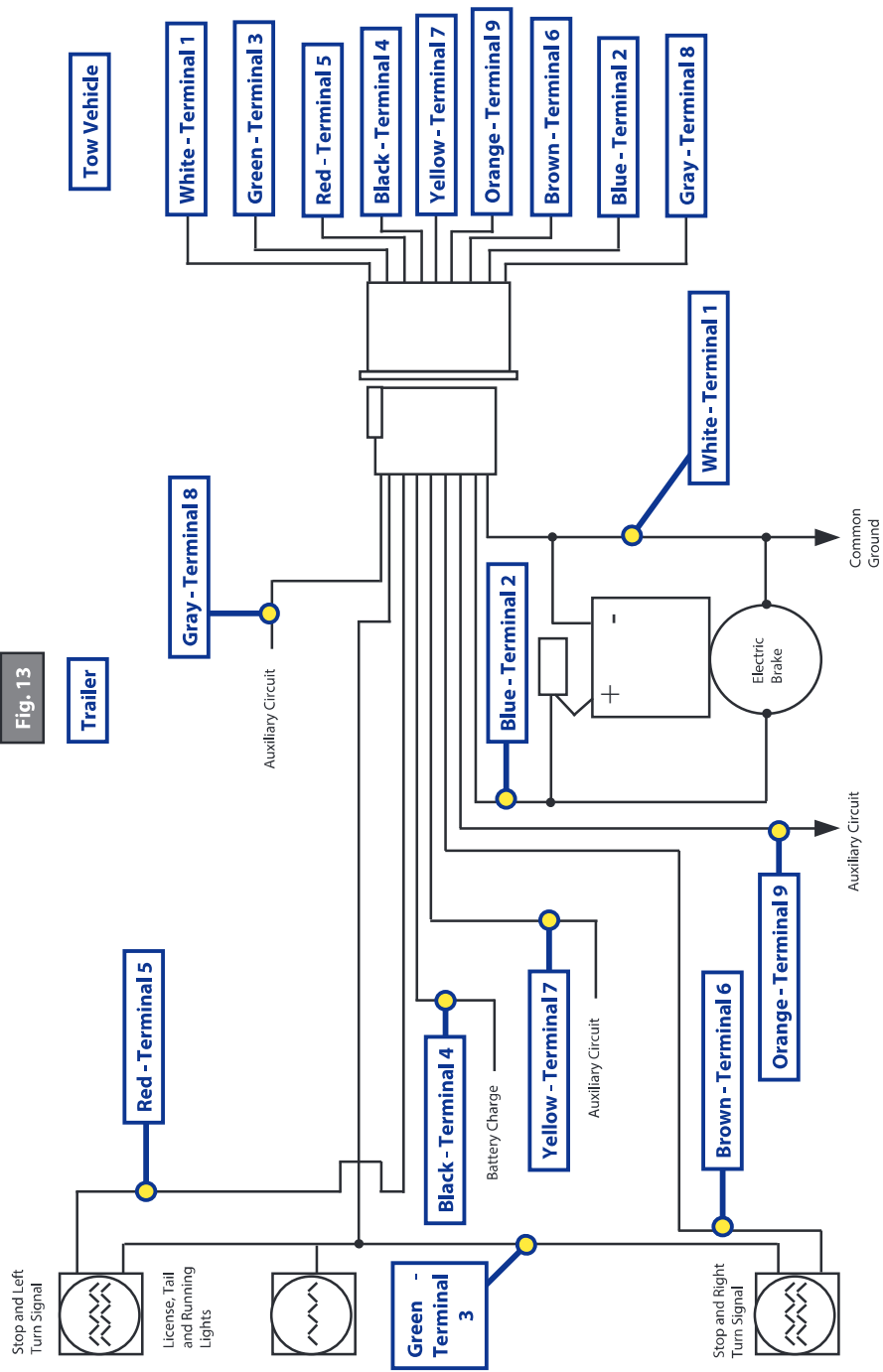
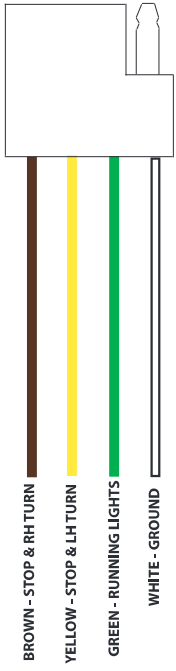

Fig. 13

Trailer

Tow Vehicle

Pigtail and Coupler Wiring Color Codes



**TRAILER LIGHTS PIGTAIL - DOES NOT OPERATE BRAKES**

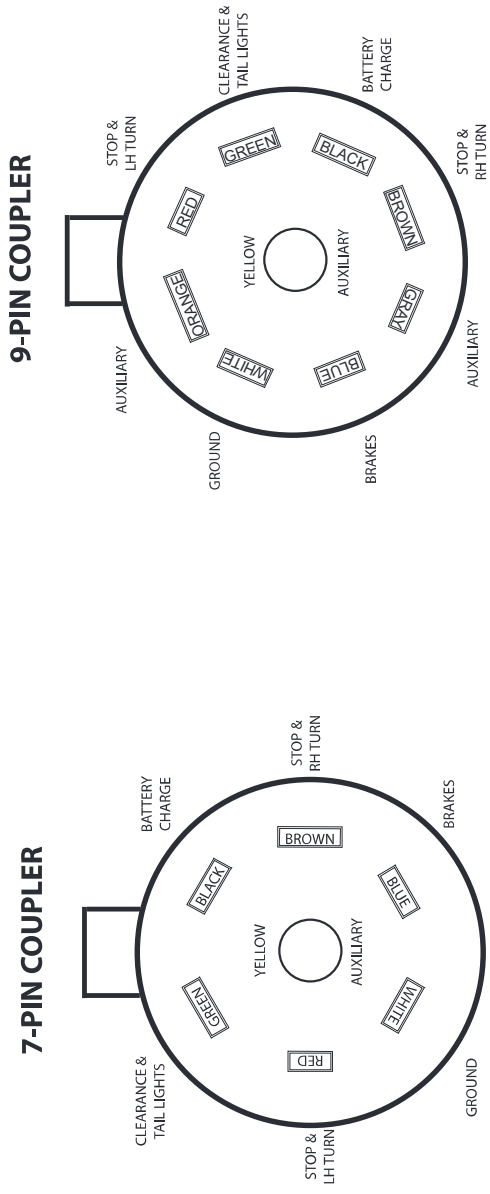

**TRAILER BRAKE AND LIGHT COUPLER - OPERATES BRAKES**

## Safety Information



The “WARNING” symbol above is a sign that a service or maintenance procedure has a safety risk involved and may cause death or serious injury if not performed safely and within the parameters set forth in this manual.

Always wear eye protection when performing service or maintenance to the vehicle. Other safety equipment to consider would be hearing protection, gloves and possibly a full face shield, depending on the nature of the service.



**This manual provides operational procedures for Solera® Manual Awning - Crank Style. Operating the Solera® Manual Awning - Crank Style in any other manner than described may result in personal injury, damage to the recreational vehicle or the awning assembly as well as voiding the Lippert Components Limited Warranty.**

## Introduction

The Solera® Manual Awning - Crank Style extends and retracts with the easy-to-use hook-and-crank tool. Simply insert the hook into the drive head and turn clockwise to extend the awning and counter-clockwise to retract the awning. The Solera® Manual Crank Style Awning features an internal gear box that allows the awning to stop at any point during extension or retraction. Additionally, the friction joint allows for rain dump and adjustable pitch features, and there is no rafter arm to lock in place. The friction joint also provides added stability — the arms don't need to be locked in place like other manual awnings.

## Operation

### Extending The Awning

1. Locate the locking latch (Fig. 1) (if equipped) on the drive side awning arm. Unlock the latch (Fig. 2).

**NOTE:** This latch is optional and may be installed on one or both support arms.

2. Locate the manual crank handle for the awning.
3. Insert the hook end of the crank handle into the eye bolt on the drive head (Fig. 3A).
4. Turn the crank in a clockwise direction and fully extend the awning (Fig. 4).

**NOTE:** Extension is considered complete when the awning valance seam reaches the leading edge of the roll tube and a section of the roll tube is exposed (Fig. 5).



**Tying the roll tube down once extended will not allow the free floating support arms to work as designed and may cause damage to the awning or RV.**

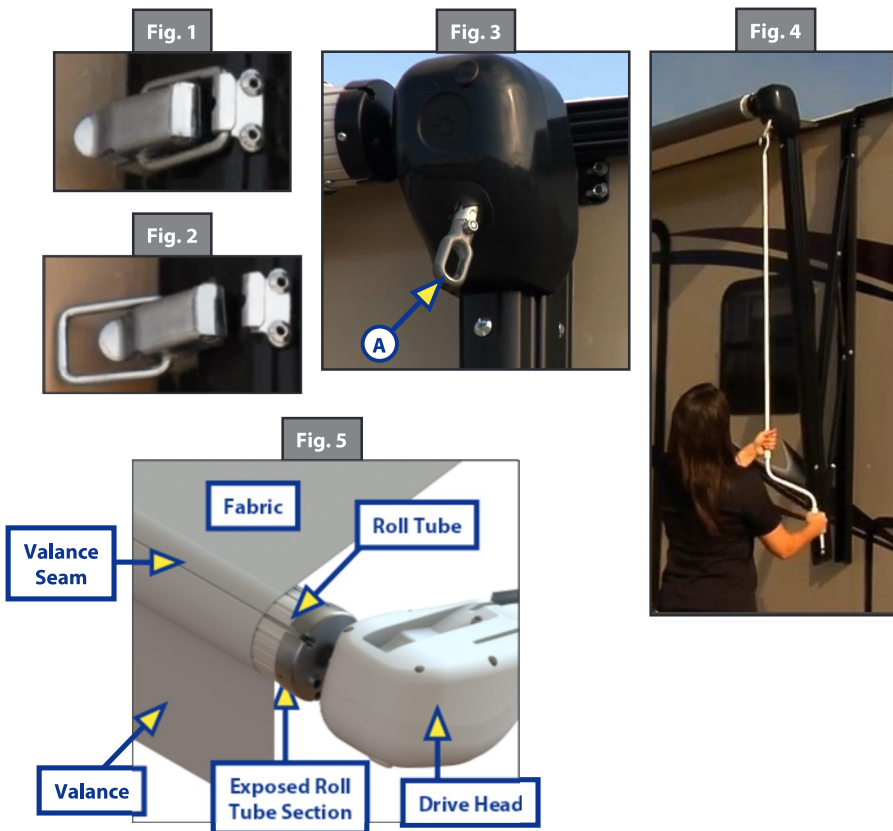

### Retracting The Awning

**NOTE:** The awning can be retracted without resetting the pitch (see next page).

1. Insert the hook end of the crank handle into the eye bolt on the drive head (Fig. 6).
2. Turn the crank handle in a counter-clockwise direction until the awning is fully retracted (Figs. 7 and 8).

**NOTE:** Keeping handle even with the roll tube makes it easier to turn.

3. Locate the locking latch (Fig. 9) (if equipped) on the drive side awning arm. Lock the latch to secure the awning in place (Fig. 10).

**NOTE:** This latch is optional and may not be installed. If not installed, awning is secured and ready for transportation.

Fig. 6



Fig. 7



Fig. 8

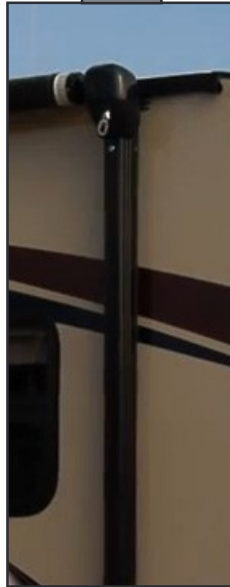

Fig. 9



Fig. 10



## Adjusting Pitch

**NOTE:** The awning will pitch itself to purge excessive water and may dump a significant amount of water without notice.

1. Pitch can be set manually by adjusting the articulating arm to tip one side of the awning to allow water runoff.
2. Extend awning to desired location.
3. Choose the side of the awning for optimum or convenient water runoff. Pull downward on the joint of the articulating arm (Fig. 11) until pitch is set to allow for water runoff. Do not push the articulating arm up past straight. This will put tension on the gas strut which can cause the strut to break. Belleville washers and bolt allow for the joint (Fig. 12A) to remain in the position set by the operator.

**NOTE:** The awning can be retracted without resetting the pitch.

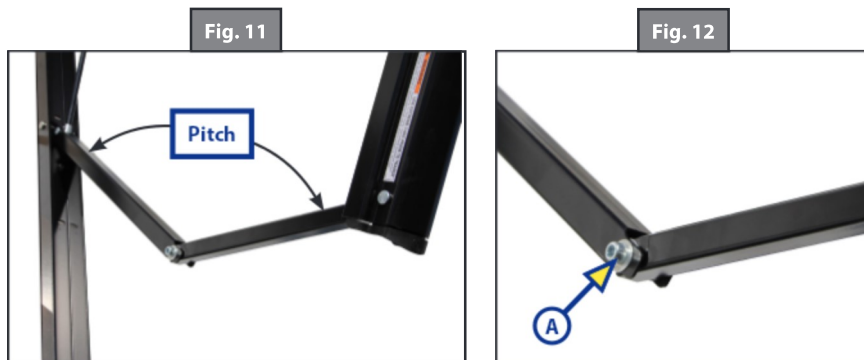

## Fabric Care

If the awning is rolled up while wet, roll it out and let it dry as soon as conditions allow before rolling it up again. This will help prevent the formation of mildew and add greatly to the life of the awning. Mildew does not form on the fabric itself, but on the accumulated dust, dirt and grime.

**NOTE:** Periodically clean vinyl or woven acrylic fabric using a mixture of ¼ cup of dish soap mixed with 5 gallons of warm water. Liberally slobber the mixture on the top of the fabric and roll the awning up for 5 minutes. This will apply the mixture to the bottom of the fabric as well. Roll it out and hose off with fresh water. Repeat if necessary. Allow to dry before rolling up.

## Ordering Replacement Components

1. Locate the Solera® label on the roll tube.
2. Locate the variant code at the bottom of the label.
3. Call LCI Customer Service at (574) 537-8900 and provide the variant code.

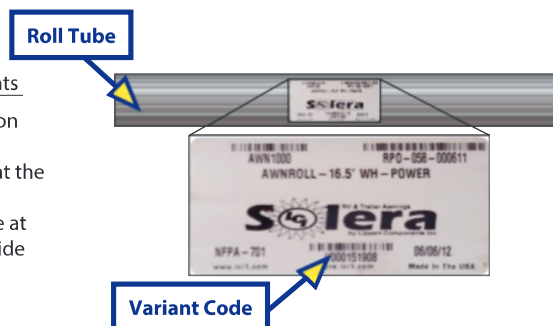

## Safety Information

### ⚠ WARNING

The "WARNING" symbol above is a sign that a service or maintenance procedure has a safety risk involved and may cause death or serious injury if not performed safely and within the parameters set forth in this manual.

Always wear eye protection when performing service or maintenance to the vehicle. Other safety equipment to consider would be hearing protection, gloves and possibly a full face shield, depending on the nature of the service.

### ⚠ CAUTION

**This manual provides operational procedures for Solera® Manual Awning - Pull Strap Style. Operating the Solera® Manual Awning - Strap Style in any other manner than described may result in personal injury, damage to the recreational vehicle or the awning assembly as well as voiding the Lippert Components Limited Warranty.**

## Introduction

The Solera® Manual Awning - Pull Strap Style extends and retracts with the easy-to-use rod and pull strap combination. Additionally, the friction joint allows for rain dump and adjustable pitch features, and there is no rafter arm to lock in place. The friction joint also provides added stability — the arms don't need to be locked in place like other manual awnings.

## Operation

### Extending The Awning

1. Locate the locking latch (Fig. 1) (if equipped) on the drive side awning arm. Unlock the latch (Fig. 2).

**NOTE:** This latch is optional and may be installed on one or both support arms.

2. Using the pull rod, place the "L" end of the rod on top of the cam lock (Fig. 3A) and pull down on the lock to release it (Fig. 3).

Fig. 1



Fig. 2



Fig. 3





3. Insert the pull rod into the pull strap (Fig. 4).
4. Pull strap to chest height using the pull rod. Using hands to grasp strap, walk the awning outward, keeping in front of the roll bar at all times (Fig. 5).

**NOTE:** Extension is considered complete when the awning valance seam reaches the leading edge of the roll tube and a section of the roll tube is exposed (Fig. 6). Also check to make sure cam lock is on top of the roll tube.

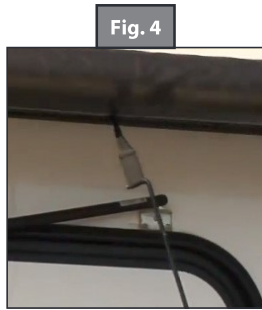

Fig. 4

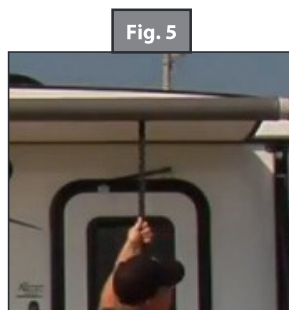

Fig. 5

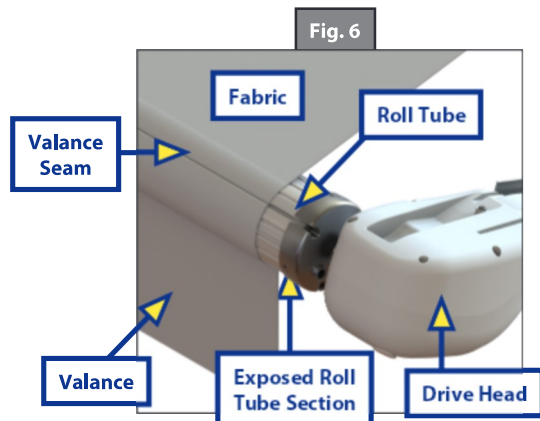

Fig. 6



**Tying the roll tube down once extended will not allow the free floating support arms to work as designed and may cause damage to the awning or RV.**

## Retracting The Awning

**NOTE:** The awning can be retracted without resetting the pitch (see next page).

1. Grasping the strap, pull slightly toward you (Fig. 7) to release pressure on the cam lock (Fig. 7A) and disengage the cam lock.
2. While holding strap in hand, walk awning toward coach until the strap is about chest height (Fig. 8).

Fig. 7



Fig. 8



3. Insert pull rod into the pull strap.
4. Walk awning all the way in until it stops (Figs. 9 and 10). Remove pull rod from strap.
5. Locate the locking latch (Fig. 11) (if equipped) on the drive side awning arm. Lock the latch to secure the awning in place (Fig. 12).

**NOTE:** This latch is optional and may not be installed. If not installed, awning is secured and ready for transportation.

Fig. 9



Fig. 10



Fig. 11



Fig. 12

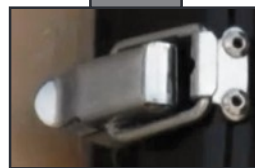

## Adjusting Pitch

**NOTE:** The awning will pitch itself to purge excessive water and may dump a significant amount of water without notice.

1. Pitch can be set manually by adjusting the articulating arm to tip one side of the awning to allow water runoff.
2. Extend awning to desired location.
3. Choose the side of the awning for optimum or convenient water runoff. Pull downward on the joint of the articulating arm (Fig. 13) until pitch is set to allow for water runoff. Do not push the articulating arm up past straight. This will put tension on the gas strut which can cause the strut to break. Belleville washers and bolt allow for the joint (Fig. 14A) to remain in the position set by the operator.

**NOTE:** The awning can be retracted without resetting the pitch.

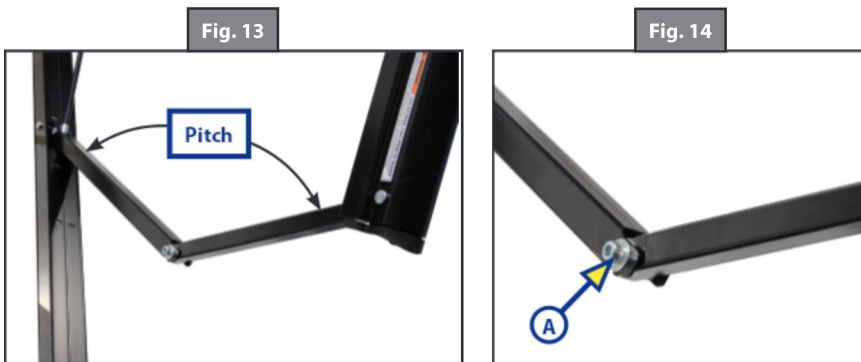

## Fabric Care

If the awning is rolled up while wet, roll it out and let it dry as soon as conditions allow before rolling it up again. This will help prevent the formation of mildew and add greatly to the life of the awning. Mildew does not form on the fabric itself, but on the accumulated dust, dirt and grime.

**NOTE:** Periodically clean vinyl or woven acrylic fabric using a mixture of ¼ cup of dish soap mixed with 5 gallons of warm water. Liberally slosh the mixture on the top of the fabric and roll the awning up for 5 minutes. This will apply the mixture to the bottom of the fabric as well. Roll it out and hose off with fresh water. Repeat if necessary. Allow to dry before rolling up.

## Ordering Replacement Components

1. Locate the Solera® label on the roll tube.
2. Locate the variant code at the bottom of the label.
3. Call LCI Customer Service at (574) 537-8900 and provide the variant code.

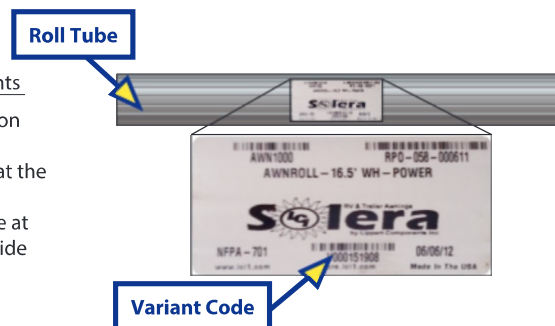

## Safety Information



The “WARNING” symbol above is a sign that a service or maintenance procedure has a safety risk involved and may cause death or serious injury if not performed safely and within the parameters set forth in this manual.

Always wear eye protection when performing service or maintenance to the vehicle. Other safety equipment to consider would be hearing protection, gloves and possibly a full face shield, depending on the nature of the service.



**This manual provides operational procedures for Solera® Power Awning. Operating the Solera® Power Awning in any other manner than described may result in personal injury, damage to the recreational vehicle or the awning assembly as well as voiding the Lippert Components Limited Warranty.**

## Introduction

Our full line of premium Solera® Power Awnings not only shade and shelter from the elements, but provide additional options unmatched by the competition. The Solera Power Awning features the industry's first easy-to-access manual override. Users can simply use a power drill to extend and retract the awning in case of power failure. The strong, anti-scuff, anti-mildew fabric is cold-crack protected up to minus 25 degrees and the awning's innovative friction joint allows users to easily adjust the pitch and does not require readjustment before retracting the awning.

## Operation

### Extending The Awning

1. Verify the RV battery is fully charged and connected to the electrical system.
2. Locate the locking latch (Fig. 1), if equipped, on the drive side support arm and unlock the latch (Fig. 2).

**NOTE:** This latch is optional and may not be installed.

3. Press and hold EXTEND (Fig. 3A) until the awning is extended completely.

**NOTE:** Extension is considered complete when the awning valance seam reaches the leading edge of the roll tube and a section of the roll tube is exposed (Fig. 4).



**Over extending the awning will roll the awning back up the wrong way and could damage the system and will void the Limited Warranty.**  
**Tying the roll tube down once extended will not allow the free floating support arms to work as designed and may cause damage to the awning or RV.**

### Retracting The Awning

1. Verify the battery is fully charged and connected to the electrical system.

**NOTE:** The awning can be retracted without resetting the pitch (see next page).

2. Press and hold RETRACT (Fig. 3B) until the awning is retracted completely.
3. Locate the locking latch (Fig. 2), if equipped, on the drive side awning arm and lock the latch to secure the awning in place (Fig. 1).

**NOTE:** This latch is optional. If not installed, awning is secured and ready for transportation.

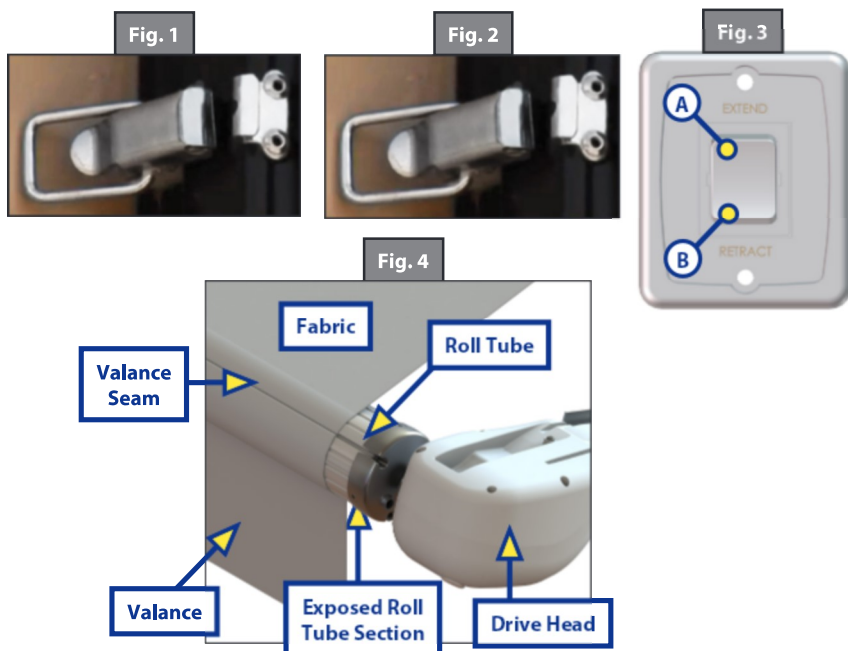

### Adjusting Pitch

**NOTE:** The awning will pitch itself to purge excessive water and may dump a significant amount of water without notice.

1. Pitch can be set manually by adjusting the articulating arm to tip one side of the awning to allow water runoff.
2. Extend awning to desired location.
3. Choose the side of the awning for optimum or convenient water runoff. Pull downward on the joint of the articulating arm (Fig. 5) until pitch is set to allow for water runoff. Do not push the articulating arm up past straight. This will put tension on the gas strut which can cause the strut to break. Belleville washers and bolt allow for the joint (Fig. 6A) to remain in the position set by the operator.

**NOTE:** The awning can be retracted without resetting the pitch.

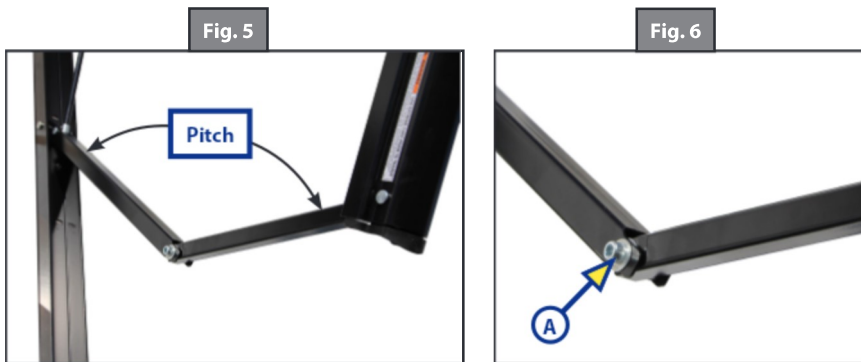

### Fabric Care

If the awning is rolled up while wet, roll it out and let it dry as soon as conditions allow before rolling it up again. This will help prevent the formation of mildew and add greatly to the life of the awning. Mildew does not form on the fabric itself, but on the accumulated dust, dirt and grime.

**NOTE:** Periodically clean vinyl or woven acrylic fabric using a mixture of ¼ cup of dish soap mixed with 5 gallons of warm water. Liberally slosh the mixture on the top of the fabric and roll the awning up for 5 minutes. This will apply the mixture to the bottom of the fabric as well. Roll it out and hose off with fresh water. Repeat if necessary. Allow to dry before rolling up.

### Ordering Replacement Components

1. Locate the Solera® label on the roll tube.
2. Locate the variant code at the bottom of the label.
3. Call LCI Customer Service at (574) 537-8900 and provide the variant code.

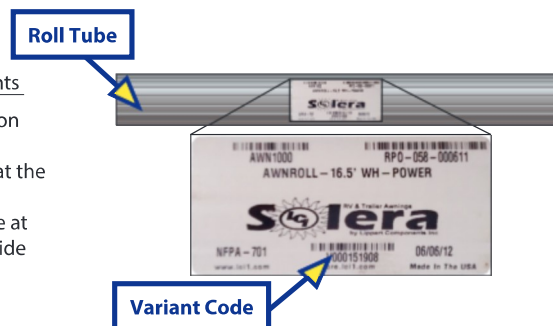

### Manual Override

In the event of power loss or motor failure, the awning can be extended and retracted manually. Perform the following procedure to manually retract the awning.

1. Remove rubber grommet from the drive head assembly exposing the manual override nut on the motor (Fig. 7A).

**NOTE:** The drive head assembly is always located on the right side of the awning as it is viewed from outside of the coach.

2. Using a  $\frac{7}{16}$ " socket and cordless/power drill, spin the manual override nut counterclockwise to retract the awning (Fig. 8).

**NOTE:** A ratchet can be also be used to turn the manual override nut.

**NOTE:** Use caution when retracting manually as the use of a step stool or ladder may be required to completely retract the awning.

3. When the awning is completely retracted, remove socket or drive device and replace rubber grommet in the drive head assembly.

**NOTE:** The motor's internal drive system prevents the awning from moving (extend or retract) on its own. If the motor is damaged or disabled, be sure to secure the awning in the retracted position with a strap around both the outer support arm and the mounted support arm before the override nut is released.



During incidents of high wind, heavy rain or extended time away from the unit, it is advisable to retract the awning completely to prevent damage to the awning and the RV.

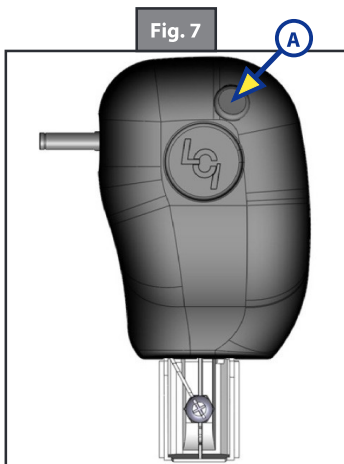

1. Fastec door latches are installed on about 98% of all entry doors in the RV industry. They are the only manual latch used by Lippert Components, Inc.
2. LCI Fastec door latch comes in 3 colors; Black-50% usage; White - 40% usage; Chrome - 10%.
3. There are 25 different keys used for the manual door latches.
4. The Fastec Key code is stamped into the key as a 5 character code, e.g. HF 345 (Fig. 1).

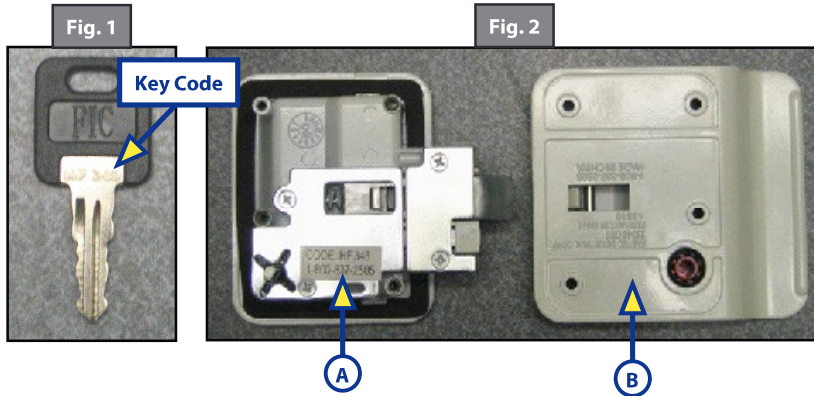

5. Standard key will have a square, black plastic coating on the key handle and will have "FIC" molded on the face.
6. In the event of a lost key, the key code can be found on a sticker affixed to the back plate of the latch (Fig. 2A).
7. Fastec's toll free number will also be listed - (800)837-2505.
8. Remove the four mounting screws found on the inside door latch. Remove inside latch to reveal key code sticker (Fig. 2B).
9. A Master Key will have the same characteristics only in red plastic. The Master Key will only open the door lock and not the deadbolt.



## Installation

### Removal of Existing Handle

1. Securely latch the door in the open position to make it easy to work on. This will keep it from moving while you are working.
2. Remove the four screws from the back of the existing handle; the back of the handle will fall away from the door.
3. Remove the two screws and the strike plate from the side of the door; you will now be able to remove the front portion of the handle.
4. Store all of the parts you just removed for possible future needs. New installation parts as well as screws are provided with your new RV Lock™ Handle. NOTE: At this point you are ready to install and program your new RV Lock™ handle with your remote(s) and/or keypad.

### Installing The RV Lock™

1. After carefully removing your new RV Lock™ from its packaging, place all the parts on a soft towel to avoid scratches and dings.
2. Pull red tab to energize battery compartment. To change or verify batteries in handle, remove the two screws holding the plastic battery cover and install four AA alkaline batteries.

**NOTE:** Batteries last around 5-6 months. Remove batteries at end of season and/or during large gaps between trips to avoid draining batteries and possible acid damage.

3. Replace the battery cover making sure not to over tighten screws.
4. Slide the front of your new RV Lock™ handle into the opening on the front of the door. While sliding it in, gently pull the wires ahead of the lock and through the opening making sure that they are not getting pinched. While holding the front handle in the door so that it does not fall, attach the new strike plate with the 2 shorter screws on the doors jamb side.
5. While holding the back portion of your RV Lock™ handle, connect the battery wires to the front portion of the handle that is already in the door. Make sure you hear the confirmation beep that the power has been connected.
6. Carefully align and attach the back handle while gently tucking excess wires into the void area. Holding the paddle of the back handle closed while inserting the paddle tooth into the front handle will make sure of a proper and aligned fit.

**NOTE:** Make sure not to pinch or cut wires during installation and make sure all wires are tucked out of the way of each screw opening and the mechanical parts of the handle. We are not responsible for wires damaged during installation.

7. Next install the four longer installation screws, but be patient and read ahead as this is the most technical part of the installation – a long, skinny #2 Phillips screwdriver will make this much easier. Make sure not to cross-thread the screws and do not scratch the side of the paddle portion of the handle while fastening the screws. Only tighten the screws tight enough to keep the lock securely against the door and do not tighten the screws at this point.
8. With the four semi-tightened screws in place, adjust the front handle in place so it is straight in the opening and hold it there while tightening the screws in the back of the handle. Securely tighten the four screws.

### Programming The RV Lock™

1. Press the lock and unlock buttons on the RV Lock™ remote(s) or, if you have a keypad, type in the numeric code (default code is 1234) and press the lock button on the keypad to make sure the lock
2. functions. If they function, go to step 2.
3. Press the learning button with a paper clip and then release after you hear a short beep. (This button is located through a pin hole under the interior handle. Lift the interior handle to see the pin hole.)
4. After you hear the “programming mode” beep, repeat pressing the lock button on your RV Lock™ remote, or if you have the RV Lock™ keypad, repeat typing in your numeric code and then pressing the lock button on the keypad until your RV Lock™ handle confirms the programming with a series of fast beeps. You have approximately 10 seconds. (Example: 1-2-3-4 lock, 1-2-3-4 lock, 1-2-3-4 lock) Default code for all new keypads is 1234. If programming did not work or if you have additional remotes/keypads to program, repeat steps 2 and 3.
5. You have successfully finished the installation! Please always keep keys on the outside of the coach to avoid accidental lock out.

**NOTE:** Make sure to place your keys and these instructions in the glove box of your truck or somewhere on the outside of the trailer, so they are available when and if you need them. Do not place your keys or these instructions in the trailer.

#### Programming A New Code Into Your RV Lock™ Keypad

1. Write your desired “new” code down and then read through all instructions before you start the programming process as this will make the programming much easier.
2. While holding down the “0” button, press and release the “lock” button, then release the “0” button as well. (You will hear a long confirmation beep – this signifies that you have entered the programming mode).
3. Type in the keypads existing code, for example 1234, then press lock. (1234 is the default code from the factory and only works until it has been changed).
4. Now type in the new code written down (up to 8 digits), then press lock.
5. Again type in the same new code as written and again press lock. (Repeat this until a long confirmation beep from the keypad confirms and completes programming).
6. Test to ensure your new code works by typing in your new code and press the lock/unlock button. The keypad should confirm the accepted code by a long beep. If not, start again at step #1.
7. Peel the double stick tape off the back of the Keypad and press firmly on a clean surface. Keypad will function best when within a closer proximity of the RV Lock™ handle (Within 15-20’).

**NOTE:** Keypad will reset to former operation after 10 seconds of being idle during programming mode. If you make a mistake simply wait 10 seconds and start over.

8. Long beep – Confirmation/Functioning
9. Five short beeps – Error/Wrong code
10. You **MUST** always have the current code to change to a new one. There is no reset button or override code. If the code has been forgotten, the keypad **MUST** be replaced.
11. Always keep your keys outside of your coach in case of electronics/battery failure.
12. The CR2032 battery can be accessed by removing the two screws that hold the battery door in place on the bottom of the keypad.
13. After installing a new battery, make sure to press battery door in firmly while tightening screws. This will allow the gaskets to seal up tight. Not pressing the battery door securely while tightening may result in water being able to access the interior of the keypad.

### Syncing The RV Lock™ Handle With Your Keypad or Remotes

1. Lightly press the learning button with a paper clip through the pin hole located under the interior handle. A beep will confirm that you have entered the programming mode.
2. Now repeat pressing the lock button on your remote until the handle confirms with a series of rapid beeps (usually takes one or two times). If you have a keypad, repeat typing in your numeric code and pressing the lock button until the handle confirms with a series of rapid beeps (usually takes one or two times).
  - A. Default code for all new keypads is 1234. If you would like to change your keypad code see "Programming a new code into your RV Lock™ Keypad" after completing this "syncing" process.
  - B. If programming did not work or if you have additional remotes to program, repeat steps 1 and 2.
  - C. You can have both a keypad and multiple remotes operating the same or multiple RV Lock™ handles.

### Keypad Programming Instructions

1. While holding the "0" button, press and release the "lock" button (Fig. 1). You will hear a long confirmation beep – entering programming mode.
2. Type in the existing code, in this case, the default code, "1234", then press lock (Fig. 2).
3. Now type in your new code (up to 8 digits), press lock.
4. Again type in your new code and press "lock". (A long confirmation beep confirms and completes programming.)
  - A. The keypad comes from the factory with the default code of "1234".
  - B. Remember, we removed the "backup" reset code/button. You **MUST** have the current code to change to a new code. There is no reset button or override code.

### RV Lock™ Handle Programming Instructions

1. Power up the RV Lock™ handle.
2. Using a paperclip, lightly press the learn button located through the pin hole on the rear of the handle next to battery cover (Fig. 3). You will hear a short

Fig. 1

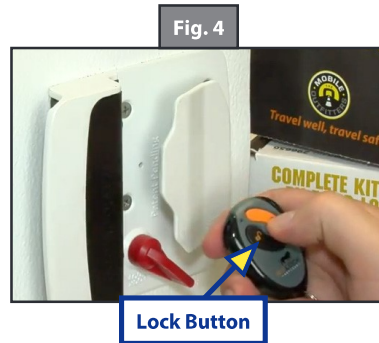
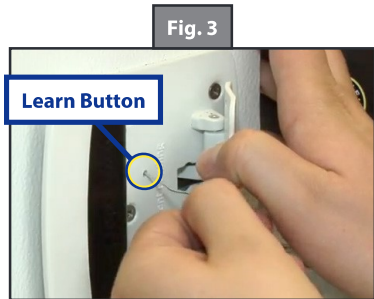

Fig. 2



confirmation beep.

3. Press the lock button on the Key Fob (Fig. 4). Repeat this process until long set of beeps confirms and completes programming, usually 2 times.



#### Troubleshooting

1. When someone has tried to open the door after the handle is locked, the dead bolt may be on a bind making it difficult for the handle to retract the dead bolt. Push the door closed tightly and retry the remote or use your key.
2. If the door is hard to shut or does not shut tight: Adjust the strike plate on the jamb side of your door.
3. Fast beeps before the lock actuates means the batteries are getting low. Batteries should last around 5-6 months in between changes.
4. To see a video of installation and programming, go to [www.rvlock.com](http://www.rvlock.com).

#### FAQs

- Q.** Can I replace my SouthCo® Keyless entry lock with the RV Lock™
- A.** The RVLock is a direct replacement/ interchangeable with Southco® Keyless Locks.
- Q.** What do I do if I lose my key?
- A.** Email [support@RVlock.com](mailto:support@RVlock.com) to request keys. Customers, OEMs and dealers can email requests for keys to the address. RV Lock™ charges \$15 for a set of keys and the key # will need to be provided. Dealers or WDs who need master keys for RV Lock sets can also address through email address listed above.
- Q.** What if I lose my key fob?
- A.** Go to [RVLock.com](http://RVLock.com) and one may be purchased direct.
- Q.** Is my wireless keypad waterproof?
- A.** Yes your wireless keypad is waterproof, however, power washing your coach or direct high impact water can breach the seal on your keypad and fill with water creating operating issues.
- Q.** What is my RV Lock™ warranty period?
- A.** RV Lock™ supplies a one year from date of purchase (DOP) as warranty term to LCI.
- Q.** If my keypad isn't functioning, do I need to return the entire lock mechanism?
- A.** No.
- Q.** Is the battery replaceable in my keypad?
- A.** Yes. Std 2032 watch battery.

## DOORS

1. Southco®, Inc. door latches are used in Lippert's Keyless Entry Door systems.
2. All Southco® units are black and the door handle is slightly curved, as opposed to the straight door handle on the Fastec.
3. Keypad (Fig. 1)
4. Keyfob (Fig. 2)
5. The Southco® key code is a 3-digit code stamped onto the key, see Fig. 3. The key handle has black molded plastic on the key handle and is rounded at the end. The Master Key bears no keycode.
6. If the key or key fob is lost, the keycode can be found on the latch plate, see Fig. 4, by removing the 4 screws on the inside latch handle.
7. Southco® can be contacted directly for key - 610-459-4000.
8. The receiver is mounted just below the entry door window.
9. The keypad and the keyfob are all matched directly to the receiver. A small black sticker with the Southco®, Inc. door latches are used in Lippert's Keyless Entry Door systems.
10. All Southco® units are black and the door handle is slightly curved, as opposed to the straight door handle on the Fastec.
11. Keypad (Fig. 1)
12. Keyfob (Fig. 2)
13. The Southco® key code is a 3-digit code stamped onto the key, see Fig. 3. The key handle has black molded plastic on the key handle and is rounded at the end. The Master Key bears no keycode.
14. If the key or key fob is lost, the keycode can be found on the latch plate, see Fig. 4, by removing the 4 screws on the inside latch handle.

Fig. 1

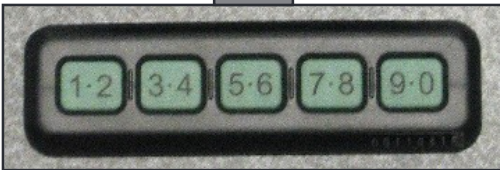

Fig. 2



Fig. 3

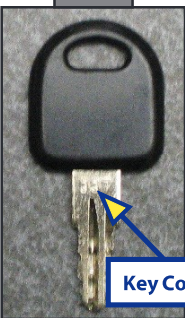
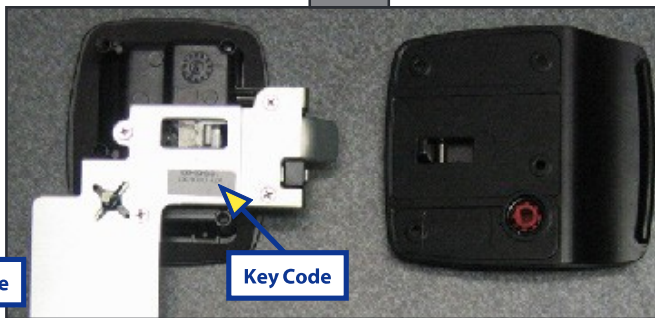

Fig. 4



15. Southco® can be contacted directly for key - 610-459-4000.
16. The receiver is mounted just below the entry door window.
17. The keypad and the keyfob are all matched directly to the receiver. A small black sticker with the code number is affixed directly to each component. On the keypad, the sticker is located under the 9-0 button (Fig. 5). On the keyfob, the sticker is in the middle of the backside of the fob (Fig. 6). The matching code will be located on the receiver next to the antenna (Fig. 7).
18. The default entry code is 1-2-3-4.

Fig. 5



Fig. 6



Fig. 7

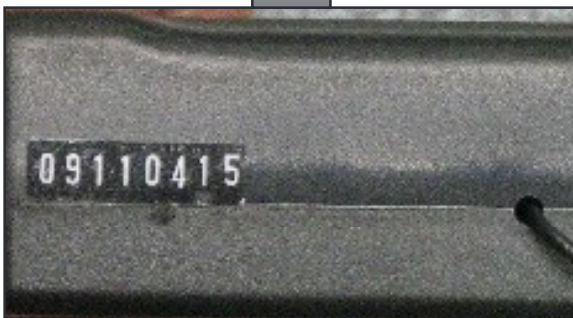









## DOORS

## Product Information

## Features

Thank-you for purchasing the Bauer NE. We have developed the Bauer NE with the idea to increase your convenience and security. We are a family owned company with over 50 years of service in the locking hardware industry, and we are grateful for the opportunity to serve you. Please review and follow the Installation, Programming and Operating Instructions to ensure proper function.

-  The first self-contained electronic RV latch with Capacitive Touch Technology.
-  An integral touch pad to the latch which controls the dead bolt.
-  Powered by 4 AA batteries.
-  Retrofit-able in most RV entry doors and easy to install.
-  Programmable with a 4-digit PIN number.
-  The large buttons are easy to see and use.
-  Proximity sensing, which illuminates the buttons.
-  An Intelligent Keyless Entry System, which knows the position of the deadbolt and indicates low battery strength, as well as provides audible feedback to successful locking and unlocking functions.
-  The key will always be able to operate the paddle or dead bolt lock in case the user forgets the code or the battery is dead.

## Operation

The Bauer NE is a 4 touch pad button programmable deadbolt lock (Fig. 1). The 4 buttons are labeled "1|2", "3|4", "5|6", "7|8". The button labeled "1|2" is the same button whether the number 1 or 2 is desired. Please note this handle uses Touch Technology. Buttons are activated by touch and do not require pressing. Touch the button and lift finger from button for proper code entry. The following steps show how to operate the Bauer Lock:

1. Touch the area next to the buttons to "Wake Up" the lock (Fig. 1B).
2. The buttons will illuminate when the lock is "awake" and will be ready to accept the code.
3. The factory default code is 3, 7, 1, 5 and is followed by the Enter button (Fig. 1C).
4. Touch and hold the  $\frac{3}{4}$  button (Fig. 1A) and Enter button (Fig. 1C) for 2 seconds. The lock will beep 3 times to accept a new code. Enter a 4-digit code followed by the Enter button (Fig. 1C). The lock will beep 4 times to indicate a new code acceptance. This is now your new code.

**NOTE:** Enter your Personal Code upon installation of lock (Step 4) to prevent inadvertent programming.

**NOTE:** The touch pad only activates the Dead Bolt. The Paddle Lock is Master Keyed for Dealer and Service Center use. The Dead Bolt provides Maximum Security.

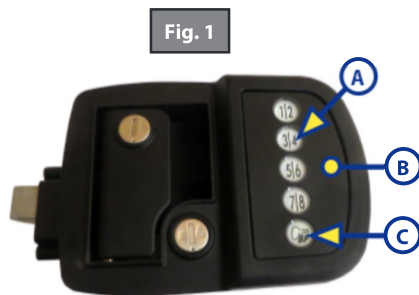

## Calibration and Programming

### Preset Factory Code





The Bauer NE has a factory set code of 3,7,1,5 followed by the Enter button. The button with the or the "\*" is the Enter button, and is required to be touched after the code is entered. The factory code resets every time the batteries are removed for at least 10 seconds.

### Programming New Code

To set a new code, touch and hold the "3|4" button and the Enter Buttons for 2 seconds. The Bauer NE will provide three short beeps, indicating it is ready to accept a new code. Enter the new 4 digit code followed by the "\*". The Bauer NE will provide four short beeps to indicate new code acceptance. This new code will now activate the lock.

To reset the code, remove the batteries for at least 10 seconds. Re-install the batteries and follow the steps to Programming New Code.

## Maintenance

-  Install fresh batteries as necessary. The Bauer NE is designed to function for months of normal usage with fresh, high quality AA batteries. Battery life is highly dependent upon battery quality, usage, and environment (temperature).
-  Make sure there are no obstructions in the door frame to prevent Dead Bolt extension.
-  Do not wash with power washer or high pressure cleaner. The Bauer NE is designed to resist water intrusion to protect its electrical components from normal water encounter such as rain.
-  The Bauer NE uses Touch Technology. The buttons are activated by touching not pressing.
-  Remove batteries when storing or not using this lock for extended periods of time.



## Installation

### Bauer NE Installation

The following steps are graphically shown on the enclosed Bauer NE Installation schematic.

1. Remove old lock.
2. Clean cut-out. Remove any dirt, loose material, etc.
3. Install outside housing (the portion that includes the Touch Pad) with the dead bolt in the unlocked position (Fig. 2A).
4. Attach the (2) 8x32 screws (Fig. 2B) into the portion of the handle that has the Plunger and Dead Bolt. This is on the edge (Fig. 2C) of the door.
5. Plug wire from Inside Plate Assembly (Fig. 2D) into the receptacle (Fig. 2E) on the housing. Make sure to align the tab on the plug properly with the slot on the receptacle. The plug should make a slight click when properly engaged.
6. Tuck Battery Wires into pocket (Fig. 2F) next to Stamped Steel Plate. Do not allow Battery Wires to get between Inside Plate Assembly and Stamped Steel Plate, as it will cause the motor to bind.
7. Align the Dead Bolt Knob in the unlocked position. The Red Dots on the Dead Bolt Knob and the Inside Plate Assembly should be aligned to indicate the unlocked position of the Dead Bolt. Slide Dead Bolt Knob over D-Stem and align the 4 screw bosses on the housing with the attaching holes on the Inside Plate Assembly. When Inside Plate Assembly is in position with Housing, install the (4) 8x32 Screws. Secure but do not over tighten screws (Fig. 2G).

Fig. 2

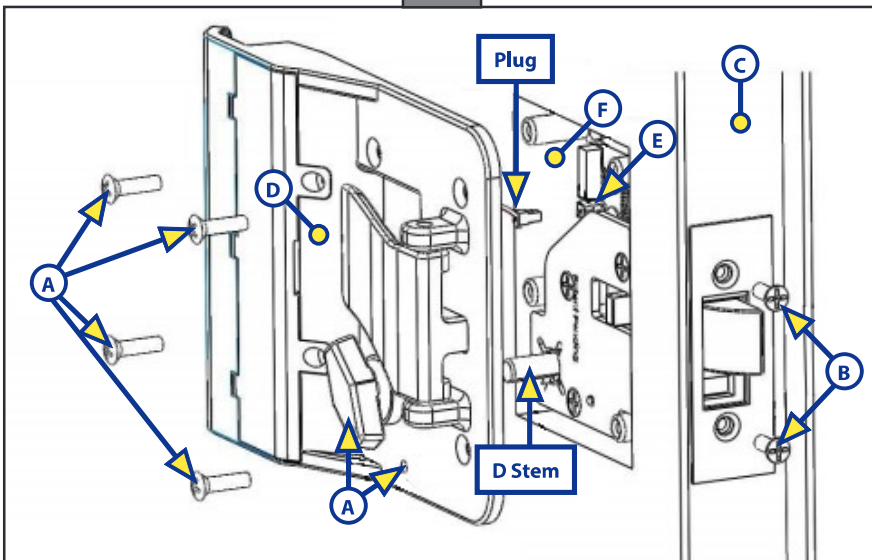

### Battery Installation

The Bauer NE uses 4 AA batteries for operation. We do not recommend zinc carbon batteries for this application. Batteries not included.

**NOTE:** Fresh batteries should be installed as necessary. Battery Life is highly dependent upon battery quality, usage, and environment (temperature). Remove batteries if the lock will not be used for extended periods of time.

The following steps are shown on the enclosed Battery Installation diagram:

1. Remove (2) 4x40 screws (Fig. 3A) from Battery Compartment Lid. These screws are very small so please take care in removal and installation. A magnetic tip #0 point Phillips Screwdriver is recommended.
2. Install the AA batteries (Fig. 3B) in accordance with the orientation shown in the Battery Compartment (Fig. 3C). The batteries will fit tightly.
3. Install Battery Compartment Lid (Fig. 3D) by aligning the (3) tabs on the lid with the (3) slots (Fig. 3E) on the Inside Plate Assembly. These tabs act as a hinge for closing the Battery Compartment Lid.
4. Install the (2) 4x40 screws (Fig. 3A) back to attach the Battery Compartment Lid to the Inside Plate Assembly.

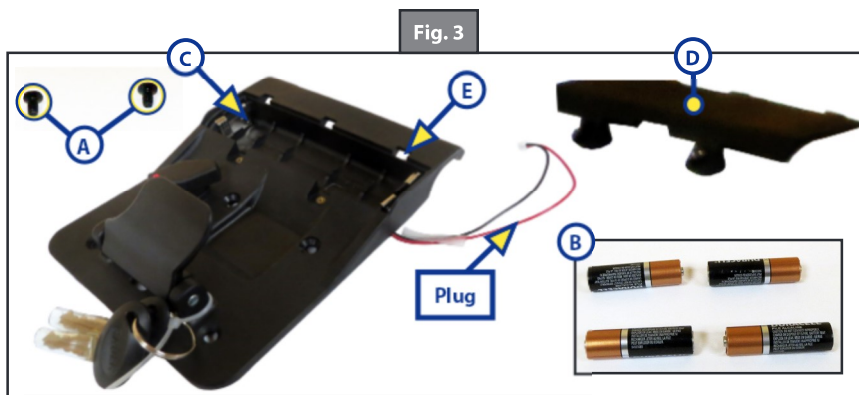

### Battery Plug Instructions

The following image shows a detailed view of the plug and receptacle for plugging the inside plate assembly into the receptacle on the Bauer housing.

1. Align tab (Fig. 4A) with small, square slot in receptacle (Fig. 4B).
2. With plug aligned, insert into receptacle until a click is heard.

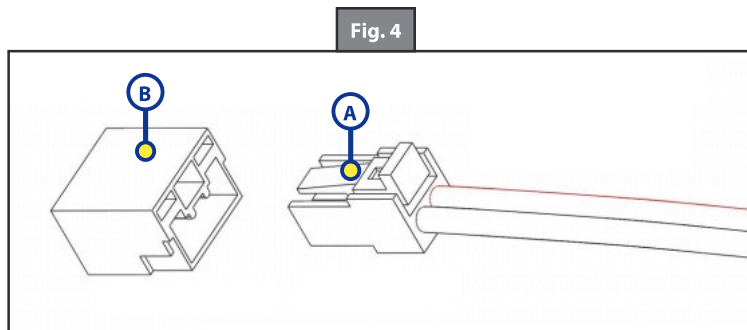

## Troubleshooting

**NOTE:** If the problem is not found on this list please call 1-866-682-2837 for assistance.

What Is Happening?	What Should Be Done?
After installation, the touch pad does not work.	Batteries are dead or are not installed properly. Plug is not engaged properly.
Dead bolt not engaging into door frame.	Obstructions in the door frame.
Code is not working.	Remove batteries for 10 seconds then program a new code.
Inside paddle is not opening the latch.	Inside screws are not secured to the housing.
Buttons light but the dead bolt does not activate.	Replace the batteries.

### Bauer NE Fault Logic

**NOTE:** The lock will cycle up to 10 more times once the low battery indication occurs. After this, the final electric function in a low battery condition will be unlock and not lock until the batteries have been replaced. Please note that if the deadbolt is in the locked position and the batteries die the deadbolt will remain locked. The key will always be able to activate the deadbolt lock.

Action	Bauer NE Response
Low Battery	1 long beep after the lock/unlock beeps
Ready to accept new code	3 short beeps
New code entered	4 short beeps
Wrong code entered	1 long beep
Dead bolt locks	2 short beeps
Dead bolt unlocks	2 short beeps
Dead bolt fails to lock	1 long beep
Dead bolt fails to unlock	1 long beep

## Limited Warranty

Bauer's warranty is limited. At its sole discretion, Bauer may either replace or repair any defective parts. In no event shall Bauer have any liability to customer for paying incidental, special or consequential damages including (without limitation) damages resulting from personal or bodily injury or death or damages to, or loss of use of, any property. Notwithstanding any provision to the contrary, this limited warranty is made upon the express understanding that shall apply in connection with the sale of the product by Bauer and is in lieu of all other warranties (Express, implied or statutory) including the separate warranties of merchantability and fitness for a particular purpose or use.

## STEPS

**Steel Step Operation**Unfolding Steps

1. Grasp step handle (Fig. 1A) firmly. Lift up slightly to disengage lock mechanism (Fig. 2A) from channel and pull entire step assembly forward. (Fig. 1 shows the steps fully retracted.)

**NOTE:** Top step slides forward, it does not fold.

2. Bottom step rests on top step (Fig. 3), then folds down.
3. Fold down bottom step (Fig. 4).
4. LCI Double Step fully extended (Fig. 5).

Folding Steps

1. LCI Double Step fully extended (Fig. 5).
2. Fold bottom step onto top step to store (Fig. 4).
3. Bottom step rests on top step to be stored (Fig. 3).
4. Grasp step handle (Fig. 1A) firmly. Lift up slightly to disengage lock mechanism (Fig. 2A) from channel and push entire step assembly back. (Fig. 1 shows the step assembly fully retracted.)

**NOTE:** Top step slides back, it does not fold.

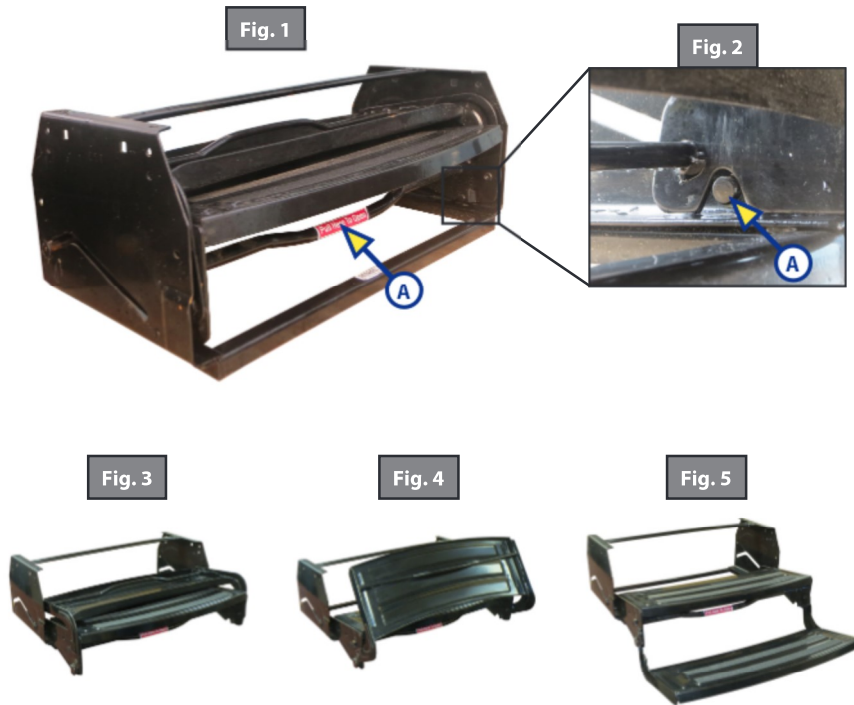

## Aluminum Step Operation

### Unfolding Steps

1. Pull out on the top lip of the step vertically stored (Fig. 6A).
2. Pull up and out on the back of step resting on the second step (Fig 7A).

### Folding Steps

1. Pull up on bottom step and fold over the second step (Fig. 7A).
2. Pull up on bottom of steps and fold inward under top step (Fig. 6A).

Fig. 6

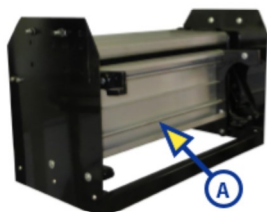

Fig. 7



Fig. 8



## Scratch Maintenance

1. Clear any chipped paint or material adhering to scratched area.
2. Apply automotive grade primer to scratch.
3. Paint primed area with automotive, high glass paint.

## Lubrication of Hinge Areas

1. Remove all dirt and foreign matter from hinge areas (Fig. 9A).
2. Lubricate hinge areas in between the sheet metal portions of the steps.
3. Utilize a dry lubricant such as silicone. Wet lubricants will attract dirt and possibly cause damage to the hinge areas.



**Do not allow lubricant to contact the actual step surfaces. Lubricant may cause slipping resulting in personal injury, property damage or death.**

Fig. 9

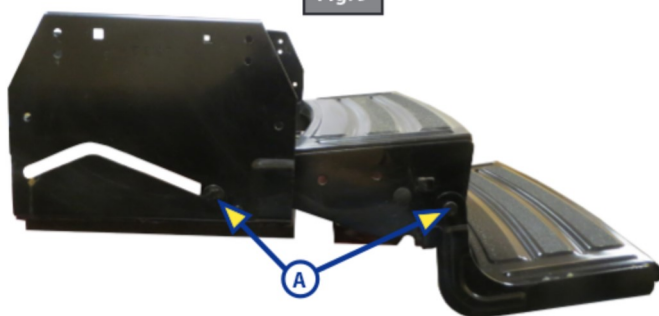

## GENERAL INFORMATION

**Lippert Chassis**Maintenance

The chassis includes the trailer frame and all attaching components; front and rear electric stabilizer jacks, scissor jacks, under chassis storage units, tire winches, sliding and bumper mounted bike racks. Wash down after winter travel on salted or otherwise treated roads or during extended period of time near coastal or salt air destinations.

The Lippert Chassis needs relatively little maintenance. The chassis and its components are powder coated to resist rust and corrosive materials that cause rust. A few simple guidelines should be kept in mind to maintain the integrity of the chassis structure.

1. Never overload the trailer. The chassis is built to the specifications for GVWR (Gross Vehicle Weight Rating) set forth by the manufacturer of the trailer. Overloading the trailer may cause damage to the structure of the chassis causing residual damage to the trailer.
2. In the event the trailer is pulled through winter conditions where salt on the road can be splashed up and onto the chassis or the trailer is pulled or located near coastal areas of the country, periodically rinsing down the chassis will wash away the corrosive salt and keep the powder coat clean.

Issues Resulting From Improper Maintenance

1. Cracks or "spider-webbing" in the powder coated surfaces.
2. Paint or powder coat flaking in large sheets.
3. Surface rust coming through powder coating.
4. Large areas of bubbling rust.

I-Beam Camber

Camber is manufactured into the unit to offset the weight of the coach rear of the axles. Loss of camber in the main rails, due to overload, i.e. excessive rear end weight, pulling a trailer behind the unit, may manifest in slide-outs, entry doors or interior cabinets not operating or functioning properly on one or both sides of the trailer. Outriggers extend perpendicular off the I-Beams of the chassis to provide an area to fasten the house portion of the trailer to the chassis. Bending outriggers will cause slide-outs, entry doors or interior cabinets to malfunction in specific areas.

Axle Hangers

Axle hangers are welded to the underside of the main rails and are brackets used to mount the axle suspension. Axle hangers should be perpendicular to the ground and parallel to the length of the main rails. Bent or damaged hangers may cause tire wear or spring issues.

## Lippert Chassis Maintenance and Inspection Schedule

Area of inspection	Inspection point	As Needed	Before use if not moved in 6 months	1 year	Every 1500-2000 miles
Couplers	Latch function		◆		◆
	Hitch Ball peeling or flat spots		◆		◆
	Ball housing metal shavings or flat spots		◆		◆
	Lubricate hitch ball Dry lube	◆			◆
	Welds not broken for cracked			◆	◆
	Dry lubricant for latch	◆			◆
Pin Boxes	Pin level/latching correctly by hitch manufacture guideline		◆		◆
	Skid plate bent/cracked or damaged		◆		◆
	Welds not broken or cracked			◆	◆
	Hitch rating sticker			◆	
	Side plate bolts not cracked, bent or damaged		◆		◆
	Grease contact surface during use(skid plate or hitch plate)	◆			◆
	Bolt torque 95-110FT pounds		◆		◆
	Bolt holes on side plates no cracking or damaged		◆		◆
General weld checks(broken or cracked)	A-Frame/Draw bars			◆	◆
	Upper Deck Risers			◆	◆
	Axle hangers			◆	◆
	Outriggers			◆	
	Chain elbow cracking or damage (holds your safety chains on travel trailers)			◆	
Powder Coating	Clean regularly (dirt and salt can cause rust,bubbling,flaking, and spider-webbing)	◆			

## Lippert Chassis Maintenance and Inspection Schedule

Area of inspection	Inspection point	As Needed	Before use if not moved in 6 months	1 year	Every 1500-2000 miles
Accessory Hitches	Welds not broken or cracked			◆	◆
	Hitch not bent or twisted			◆	
	Hitch rating sticker			◆	
Stabilizer Jack Brackets	Cracked or damaged		◆		◆
	Bolts are not broken or bent (where applicable)		◆		◆
Axle Hangers	Welds not broken or cracked			◆	◆
	Axle bolt and holes no cracking or damaged		◆		◆
	Axle bolts tight 30-50FT pounds spring axles. Torsion axles 120-150 ft pounds		◆		◆
Safety chains	Latch function		◆		
	Bolts are not cracking or damaged for bolt-on safety chain			◆	◆
	Cracking or damage		◆		◆
landing gear/ Leveling system brackets	Welds not broken or cracked			◆	
	Bolts are tight 30ft pounds for front electric LG bracket. 52-64Ft pounds for electric/hyd level up legs to bracket		◆		◆
	Cracking or damage to brackets and bolts		◆		◆
Main Rails	I beam or tube not cracking or damaged			◆	◆
Detachable A-frame/Draw bars	Bolts are tight 95-110ft pounds		◆		◆
	Cracking or bent bolts on detachable plates		◆		◆
<p><b>NOTE:</b> Some of the items above are marked twice, please inspect which ever comes first. If there are any issues with any of these items please see your local RV dealership for repair or further inspection. Any fabrication or addition of Non-OEM parts will void chassis warranty.</p>					



Lippert Chassis Maintenance and Inspection Schedule

Area of inspection	Inspection point	As Needed	Before use if not moved in 6 months	1 Year	Every 1500-2000 miles
Trail Air Pin Boxes	Pin level/latching correctly according to hitch manufacturer's guideline.		◆		◆
	Skid plate (Fig 1E) for bends, cracks, or other damage.		◆		◆
	Hitch rating sticker (Fig. 1G)			◆	
	Welds not broken or cracked			◆	◆
	Side plate (Fig. 1M) bolts not cracked, bent, or damaged.		◆		◆
	Grease contact surface during use (skid plate or hitch plate)	◆			◆
	Bolt torque 95-110 ft-lb on side plates		◆		◆
	Bolt holes (Fig. 1L) on side plates not cracked or damaged.		◆		◆
	Grease zerks greased (9 total) (Fig 1H and J) (where applicable)				◆
	Air bag (Fig. 1C) ride height verified on shock (Fig. 1B).	◆	◆		
	Air bag leak check using soapy water (spray entire air bag and look for bubbling while under load).	◆			◆
	Shock and pivot mounting bolts Fig. 1A,D,and K torqued to 95-110 ft-lb		◆		◆

**NOTE:** Recommended bag pressure is 100 PSI max. PSI will vary for each unit depending on load.

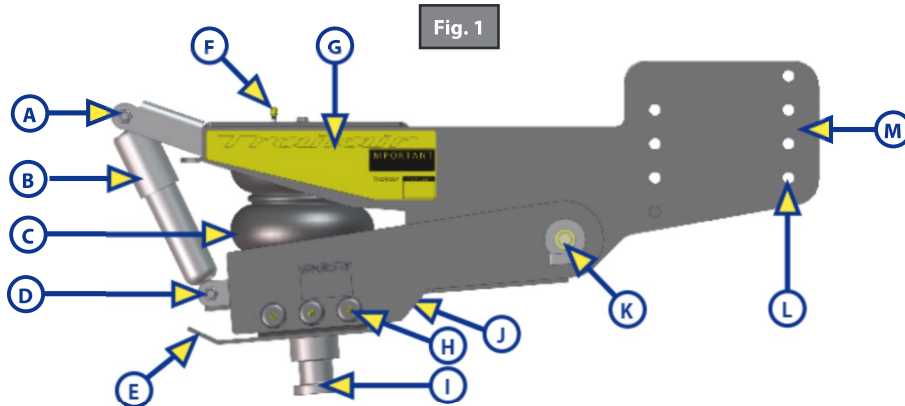

Fig. 1

Rev: 09.25.2015 - Towable Master Owners Manual

## Axles



### Bearings

Service and Repack every 12 months or 12,000 miles. See Lippert Trailer Axle Manual (Page 77) for procedure and grease specs. See also Technical Information Sheet TI-081.

### Brakes

For brake inspection and maintenance, see LIP Sheet TI-082. New brake assemblies **MUST** go through the Break-In Period to set initial contact. Technical Information Sheet TI-086.

### Connecting Components

-  Equa-Flex - Grease every 5,000 - 8,000 miles.
-  Center Point - Check for proper inflation indicated by arms positioned vertically.
-  Wet Bolts - Grease every 5,000 - 8,000 miles.

### Recommendations For Jacking The Frame To Change A Tire

1. Carrying a jack rated for the weight of the coach is essential. The jack **MUST** be rated between 8 and 12 tons.
2. To prevent damage to the coach, carry wood blocks to place between the jack and the main rail (I-beam or tube) of the coach and to go under the jack.
3. DO NOT jack the coach on the axle tube or black pipe gas lines that can sometimes be mounted to the bottom of the main rail.



4. Chock the wheels, both front and rear, on the opposite side of the coach.
  5. If hitched to tow vehicle, stay hitched and set the parking brake.
- DO NOT use the front landing gear, leveling system (if equipped), or rear stabilizer jacks to pick the coach up to change a tire. This is dangerous and may result in death or serious bodily injury.**

## Kinro

### Windows

Inspect glazing around window to be free of damage, cracks or holes and that glazing goes completely around the window. Replace if damaged.

### Cargo Doors



Inspect seals for damage, cracks or holes. Replace if damaged.

### Ramp Doors

Inspect seals for damage, cracking or holes.



## Slide-Outs

Inspect for dirt.



-  Inner Arms - Extend and wipe down and apply dry lube only.
-  Hydraulic Cylinder - Extend and wipe down piston rod and apply dry lube.  
Inspect hoses and hose fittings at cylinder for leaks.
-  Electric Actuator - Extend and wipe down inner actuator and apply dry lube. Do not leave extended for long periods of time.

**NOTE:** If unit is near coastal areas or exposed to salt air, maintain above components at least once a month.

## Electric Landing Gear

-  Extend jacks and wipe down inner and outer jacks and apply dry lube to inner.
-  Inspect bevel gears in top of jack to be free of dirt and contamination.









## Hydraulic Landing Gear - Level-Up Jacks - Rear Hydraulic Stab Jacks

-  Wipe down inner and outer. Rinse outer after winter travel or coastal or salt air travel. Extend and apply dry lube to inner and piston rod where applicable.
-  Inspect Hoses and hose fittings for leaks.

## Hydraulic Power Units

Inspect for leaks around ports, hoses and fittings. Be sure fluid in reservoir is full to within ¼" of the top.

## Maintenance Free Systems

-  Touch audio
-  TV lift
-  Wireless remote systems
-  Keyless entry
-  Door alarm
-  Door and slam latches
-  Entry doors
-  Manual steps
-  Coachsteps



# L I P P E R T C O M P O N E N T S<sup>®</sup>

The contents of this manual are proprietary and copyright protected by Lippert Components, Inc. ("LCI"). LCI prohibits the copying or dissemination of portions of this manual unless prior written consent from an authorized LCI representative has been provided. Any unauthorized use shall void any applicable warranty. The information contained in this manual is subject to change without notice and at the sole discretion of LCI. Revised editions are available for free download from [www.lci1.com](http://www.lci1.com).

Please recycle all obsolete materials.

For all concerns or questions, please contact  
Lippert Components, Inc.

Ph: (574) 537-8900 | Web: [www.lci1.com](http://www.lci1.com) | Email: [customerservice@lci1.com](mailto:customerservice@lci1.com)

This manual has been provided courtesy of  
My RV Works, Inc.

[www.myrvworks.com](http://www.myrvworks.com)



You can find more RV service manuals here:

[www.myrvworks.com/manuals](http://www.myrvworks.com/manuals)

Over the years of running a mobile RV repair service, having a dedicated place to access service manuals for all the different appliances and components found on RVs was something that I always had a desire to create.

I hope this resource makes your RV repairs easier, as it has mine, but please be careful and follow proper safety practices when attempting to repair your own RV.

If in doubt, please consult with a professional RV technician!



DARREN KOEPP - OWNER, MY RV WORKS, INC.

*All service manuals provided on [www.myrvworks.com](http://www.myrvworks.com) are believed to be released for distribution and/or in the public domain.*